

DEPARTMENT OF THE ARMY TECHNICAL MANUAL

---

FIELD MAINTENANCE MANUAL

VOLTMETER, ELECTRONIC

JOHN FLUKE MODEL 803D

FSN 6625-072-4303

This copy is a reprint which includes  
current pages from Change 1.

---

HEADQUARTERS, DEPARTMENT OF THE ARMY

MARCH 1964

## WARNING



RA PD 461691

## RADIATION HAZARD

This equipment contains the following radioactive items:

<b><i>Nomenclature</i></b>	<b><i>FSN</i></b>	<b><i>Isotope</i></b>	<b><i>Amount (Microcuries)</i></b>
OA2 Vacuum tube	5960-503-4880	UO <sub>2</sub>	0.10uc
OA2 Vacuum tube	5960-503-4880	Ni63	0.50uc
OA2 Vacuum tube	5960-503-4880	Co60	0.20uc
OG3-2 Vacuum tube	5960-912-7630	Unknown	Unknown

Refer to TM 3-261, TM 38-250, and TB 750-237 for information relative to shipping, storage, handling, and disposal of radioactive material.

## FIRST AID FOR RADIOACTIVE CONTACT

The following first aid procedure for wounds caused by anything coated with a radioactive material represents the only reasonable first aid treatment which would possibly be available.

- a. Stimulation of mild bleeding by normal pressure about the wound and by use of suction cups.

**WARNING: Do no suck the wound by mouth. The wound must be washed with soap and flushed with plenty of clear water.**

- b. If the wound is of the puncture type, or the opening is quite small, an incision should be made to promote free bleeding and to facilitate cleaning and flushing of the wound.

- c. Evacuate patient to a medical facility where monitoring of the wound can be accomplished. All such wounds should be examined by a medical officer.

- d. For wounds involving the extremities, pending medical attention, place a lightly constricting band (tourniquet) 2 to 4 inches closer to the heart than the site of the wound. The band should be tight enough to halt the flow of blood in superficial blood vessels but not tight enough to stop the pulse arterial flow).

## CLEANING SURFACES ON WHICH TUBES HAVE BEEN BROKEN

**Wet Method.** Put on rubber or plastic gloves. Pick up large fragments with forceps; then, using a wet cloth, wipe across the area. Make one wipe at a time and fold cloth in half, using the clean side for wiping each time. When cloth becomes too small, discard and start again with a clean piece of cloth. Care must be taken not to rub the radioactive particles into the surface being cleaned by using a back and forth motion. All debris and cloths used for cleaning should be sealed in a container such as a plastic bag, heavy waxed paper, ice cream carton, or glass jar for disposal.

## ERRATA AND ADDENDUM

 Model 803D/AC

This manual was intended for use with the 803D AC/DC Differential Voltmeters. The 803D/AC, however, is very nearly electrical identical to the 803D/AG. Physical and electrical differences include:

1. The Model 803D/AC is mounted in a combination instrument-transit case made of aluminum. This case meets all environmental requirements of MIL-T-945A.
2. The Model 803D/AC does not have recorder output provisions.
3. Line power input for the Model 803D/AC is by way of an MS3102A-10SL-3P connector on the front panel. A power input cable with a mating connector (MS3102A-10SL-3S), a three-prong polarized connector, and a three-prong to two-prong grounded adapter is furnished. Storage space for the input cable is provided in the lid of the combination case.
4. One set of universal test leads (part no. 699 - Hermin H. Smith, Inc., Brooklyn, New York) is provided with the Model 803D/AC. These test leads are stored in the lid with the power input cable.
5. Heater resistors R6 and R7 are not used in the Model 803D/AC because the instrument is completely enclosed by the transit case. However, a Zener oven containing a heater and a thermostat must be used to maintain the Zener diode reference element at a constant temperature. The Zener diode plugs into the inside of the Zener oven and the Zener oven plugs into a chassis mounted tube socket.
6. The line fuse is located on the front panel of the 803D/AC.
7. The 803D/AC uses a specially enclosed transformer to prevent leakage at higher operating temperatures.
8. The converter output diodes of the 803D/AC are selected for low leakage to provide for proper operation at the higher operating temperatures reached within the transit case.

To create a parts list for the 803D/AC, change the 803D list of replaceable parts as follows:

Delete:

	Front Panel Assembly	*803D/AG-435
	Converter/AC Range Switch Assembly	*803D-438
CR501, 502	Diode, silicon, 60 ma	RE22
J4, J5	Binding post, red	X2231
	Binding post insulator, dual, black	*801B-830
R1	Resistor, variable wirewound, 10K, ±10%, 2W	P10KA
R6, R7	Resistor, wirewound, 6K ±5%, 5W	R6KW
T1	Transformer, power	*803C-651
	Line cord, 3 wire	X27H
	Rubber foot	X224
	Case Assembly (cabinet model)	*803B-271
	Handle, flexible black vinyl, 5-1/2" (cabinet model)	407-101

Add:

	Front Panel Assembly	*803D/AC-403
	Converter/AC Range Switch Assembly	*803D/AC-404
CR501, 502	Diode, silicon, 60 ma, 40 PIV (selected RE22)	*803D/AC-402
T1	Transformer, power	*821A-651
	Case, instrument-transit	*803D/AC-271
	Connector (mates with line cord)	M3102A-10SL-3P
	Line cord	*803D/AC-401
	Test lead set	X2322
	Tube socket (for Zener oven)	X52
	Zener diode oven (includes heater and thermostat)	X2259

To create a schematic diagram for the 803D/AC, change the 803D schematic as follows:

REPLACE:

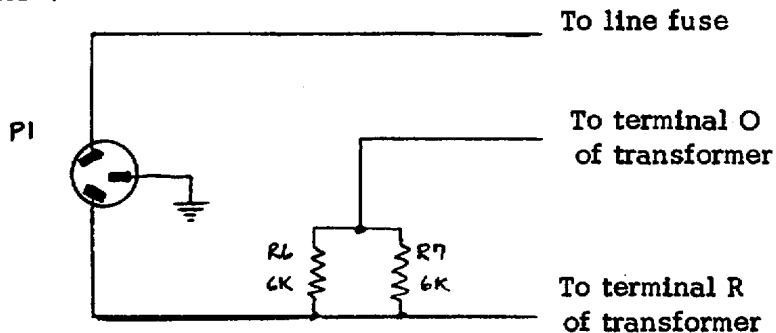

WITH:

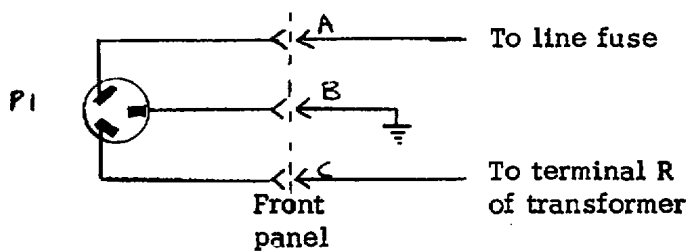

REPLACE:

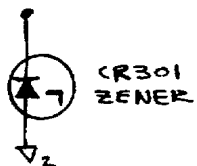

WITH:

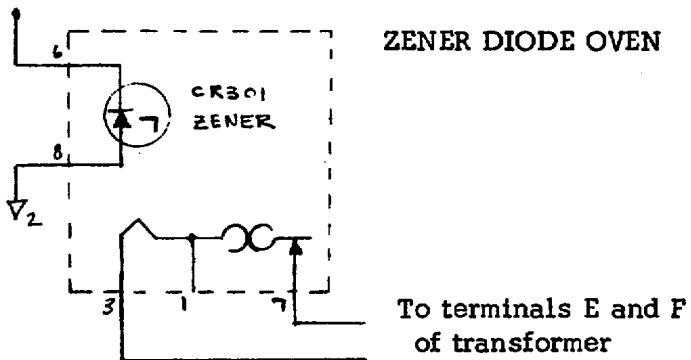

Material in this manual is used by permission of  
John Fluke Manufacturing Company, Inc.

**TABLE OF CONTENTS**

Section	Title	Page
I	INTRODUCTION AND SPECIFICATIONS	1-1
	1-1. Introduction .....	1-1
	1-2. Damage in Shipment .....	1-1
	1-3. Specifications .....	1-1
II	OPERATING INSTRUCTIONS	2-1
	2-1. Controls, Terminals, and Indicators .....	2-1
	2-2. Zeroing Instructions .....	2-3
	2-3. Preliminary Operation.....	2-3
	2-4. Operation as a DC Differential Voltmeter .....	2-3
	2-5. Operation as an AC Differential Voltmeter .....	2-3
	2-6. Operation as a Conventional VTVM.....	2-4
	2-7. Measurement of Voltage Excursions About a Nominal Value.....	2-4
	2-8. Use of 803D with a Recorder.....	2-5
	2-9. Measurement of High Resistances .....	2-6
	2-10. Notes on Measuring AC or DC Voltages .....	2-6
	2-11. Notes on Measuring DC Voltages .....	2-7
	2-12. Notes on Measuring AC Voltages .....	2-7
III	THEORY OF OPERATION	3-1
	3-1. General .....	3-1
	3-2. DC Vacuum Tube Voltmeter .....	3-1
	3-3. 0 to 500 Volt Reference Supply .....	3-3
	3-4. AC to DC Converter .....	3-4
	3-5. AC - DC Polarity Switch.....	3-4
IV	MAINTENANCE	4-1
	4-1. General .....	4-1
	4-2. Periodic Maintenance .....	4-1
	4-3. Corrective Maintenance.....	4-1
	4-4. Calibration .....	4-5
V	LIST OF REPLACEABLE PARTS	5-1
VI	ACCESSORIES	6-1
	6-1. Precision Voltage Dividers .....	6-1
	6-2. Potentiometric Recorder .....	6-2
	WARRANTY	
	CIRCUIT DIAGRAM	

LIST OF ILLUSTRATIONS

Figure	Title	Page
Frontispiece	Model 803D AC/DC Differential Voltmeter .....	iv
2-1	Controls, Terminals, and Indicators (sheet 1 of 2).....	2-1
2-1	Controls, Terminals, and Indicators (sheet 2 of 2) .....	2-2
2-2	Recommended Null Settings .....	2-3
2-3	VTVM Ranges .....	2-4
2-4	Full Scale AC Deflections .....	2-5
2-5	Recorder Recommended Connection Diagram .....	2-5
2-6	Percent Error Due to Harmonic Distortion .....	2-7
2-7	Signal Voltage with Converter Noise .....	2-8
3-1	803D AC/DC Differential Voltmeter Block Diagram .....	3-1
3-2	Function of Polarity Switch.....	3-5
4-1	Troubleshooting (sheet 1 of 2) .....	4-2
4-1	Troubleshooting (sheet 2 of 2) .....	4-3
4-2	Tube Voltage Chart .....	4-4
4-3	Calibration Equipment .....	4-5
4-4	Adjustment Locations .....	4-6
4-5	AC to DC Converter Calibration Set-up.....	4-7
5-1	Final Assembly (sheet 1 of 2).....	5-3
5-1	Final Assembly (sheet 2 of 2).....	5-4
5-2	Front Panel Assembly (sheet 1 of 2) .....	5-6
5-2	Front Panel Assembly (sheet 2 of 2) .....	5-7
5-3	Reference Supply Board Assembly .....	5-9
5-4	Null Detector Chassis Assembly.....	5-12
5-5	Range Resistor Board Assembly.....	5-14
5-6	Kelvin-Varley Resistor Board Assembly .....	5-15
5-7	Converter/AC Range Switch Assembly (sheet 1 of 2) .....	5-18
5-7	Converter/AC Range Switch Assembly (sheet 2 of 2) .....	5-19
5-8	Chopper Drive Assembly .....	5-20





## SECTION I

### INTRODUCTION AND SPECIFICATIONS

#### 1-1. INTRODUCTION

a. This instruction manual is for use with the 803D series AC/DC Differential Voltmeters. These are available in either a cabinet model or a standard 19 inch rack model, and with either a standard cell or a Zener diode as the reference element. Model designations are: 803D (cabinet model, standard cell); 803DR rack model, standard cell); 803D/AG (cabinet model, Zener diode); and 803DR/AG (rack model, Zener diode).

b. The high accuracy, portability, and compactness of the 803D make this instrument ideal for the precise measurement of almost any AC or DC voltage. Ease of operation, inherent protection from accidental overload, and high reliability contribute to the outstanding performance that assures suitability for both production line testing and precision laboratory measurements. This instrument is capable of being used as a vacuum tube voltmeter, as a precision potentiometer, and as a megohmmeter for measurement of high resistance. It can also be used to measure the excursions of a voltage about some nominal value. One feature that should be emphasized is that no current is drawn from the unknown source for DC measurements when balance is attained. Thus the determination of the unknown DC potential is independent of its source resistance. The 803D is basically used for measurements of DC voltages from 0 to 500 volts and AC voltages from 0.001 to 500 volts. However, high accuracy measurements to 30,000 volts DC are possible with precision voltage dividers especially designed for use with the Fluke Model 800 Series Differential Voltmeters. As additional features, this instrument contains a polarity switch for equal convenience in measuring positive or negative DC voltages and an adjustable recorder output which makes the 803D particularly useful for monitoring the stability of almost any AC or DC voltage. Furthermore, the 803D meter has taut-band suspension which eliminates problems due to meter stickiness.

c. When used as a DC differential voltmeter, the 803D operates on the potentiometric principal. An unknown voltage is measured by comparing it to a known adjustable reference voltage with the aid of a null detector. An accurate standard for measurements is obtained by setting the reference supply

with a standard cell for the 803D and 803DR and with a Zener reference diode for the 803D/AG and 803DR/AG. The known adjustable reference voltage is provided by a 500 volt DC power supply and five Kelvin-Varley decade resistor strings that are set accurately by five voltage readout dials. In this way, the 500 volts can be precisely divided into increments as small as 10 microvolts. The unknown voltage is then simply read from the voltage dials. When used as an AC differential voltmeter, the 803D operates essentially the same as for DC differential measurements. The AC input voltage is converted to a DC voltage and this DC voltage is measured by comparing it to a known adjustable reference voltage. In the highest recommended null sensitivity range, potential differences between the unknown and the reference voltage of only 0.001 volts for DC and 0.001 volts for AC will cause full scale meter deflection.

d. The instrument is normally supplied ready for use on 115 volts. Upon request, instruments are supplied for 230 volts operation. If it becomes desirable to convert from one mode of operation to the other, refer to the instruction decal on the back of cabinet models or on the cover in rack models.

#### 1-2. DAMAGE IN SHIPMENT

Immediately upon receipt, thoroughly inspect for any damage that may have occurred in transit. If any damage is noted, follow the instructions outlined on the warranty page at the back of this manual.

#### 1-3. SPECIFICATIONS

##### AS A PRECISION POTENTIOMETER

##### DC ACCURACY:

$\pm 0.02\%$  of input voltage from 0.1 to 500 VDC  
 $\pm (0.02\% + 25 \text{ uv})$  below 0.1 VDC

AC ACCURACY:

Input Voltage	Basic AC Accuracy		Low Frequency AC Accuracy		High Frequency AC Accuracy	
	30 cps to 5 kc	20cps to 10kc	10cps to 20cps	5cps to 10cps	10kc to 20 kc	20 kc to 100 kc
0.5 to 500	±0.1%	±0.15%	±0.5%	±2%	±0.3%	-
0.001 to 0.5	±(0.1% + 25uv)	±(0.15% + 25uv)	±(0.5%+25uv)	±(2% + 25uv)	±(0.3% + 25uv)	-
0.05 to 50	-	-	-	-	-	±1%

RANGE:

For DC Measurements

Input Voltage Range	Recommended Null Range	Input Resistance Per Volt of Input Voltage	
		At Null	1% of Full Scale Off Null
50-500	10-0-10	Infinite	100 Meg
	1-0-1	Infinite	1,000 Meg
5-50	1-0-1	Infinite	1,000 Meg
	0.1-0-0.1	Infinite	10,000 Meg
0.5-5	0.1-0-0.1	Infinite	10,000 Meg
	0.01-0-0.01	Infinite	100,000 Meg
0-0.5	0.01-0-0.01	Infinite	100,000 Meg
	0.001-0-0.001	Infinite	100,000 Meg

RESOLUTION:

Voltage Readout Dial Resolution

Range Setting	Null Setting	Resolution
500	any	10 mv
50	any	1 mv
5	any	0.1 mv
0.5	any	0.01 mv

For AC Measurements

Input Voltage Range	Recommended Null Range	Input Impedance
50-500	100-0-100	1 Meg, 35 uuf
	10-0-10	1 Meg, 35 uuf
	1-0-1	1 Meg, 35 uuf
5-50	10-0-10	1.1 Meg, 35 uuf
	1-0-1	1.1 Meg, 35 uuf
	0.1-0-0.1	1.1 Meg, 35 uuf
0.5-5	1-0-1	1 Meg, 50 uuf
	0.1-0-0.1	1 Meg, 50 uuf
	0.01-0-0.01	1 Meg, 50 uuf
0.001-0.5	0.1-0-0.1	1 Meg, 50 uuf
	0.01-0-0.01	1 Meg, 50 uuf
	0.001-0-0.001	1 Meg, 50 uuf

Meter Resolution  
(1/4 of a small scale meter division)

Polarity Setting	Range Setting	Null Setting	Resolution
DC	any	10	50 mv
DC	any	1	5 mv
DC	any	0.1	0.5 mv
DC	any	0.01	0.05 mv
DC	any	0.001	0.005 mv
AC	500	1	500 mv
AC	500	0.1	50 mv
AC	50	1	50 mv
AC	500	0.01	5 mv
AC	50	0.1	5 mv
AC	5	1	5 mv
AC	50	0.01	0.5 mv
AC	5	0.1	0.5 mv
AC	0.5	1	0.5 mv
AC	5	0.01	0.05 mv
AC	0.5	0.1	0.05 mv
AC	0.5	0.01	0.005 mv

AS A VACUUM TUBE VOLTMETER

ACCURACY: 3% of full scale

RANGE:

Voltage Ranges	Input Impedance
DC: 500-0-500	50 Meg
50-0-50	50 Meg
5-0-5	50 Meg
0.5-0-0.5	50 Meg
10-0-10*	10 Meg
1-0-1*	10 Meg
0.1-0-0.1*	10 Meg
0.01-0-0.01*	10 Meg
0.001-0-0.001*	1 Meg
AC: 0-500	1 Meg, 35 uuf
0-50	1 Meg, 35 uuf
0-5	1 Meg, 50 uuf
0-0.5	1 Meg, 50 uuf
0-100**	1 Meg, 35 uuf
0-10**	1 Meg, 35 uuf
0-1**	1 Meg, 35 uuf
0-0.1**	1 Meg, 35 uuf
0-0.01**	1 Meg, 50 uuf
0-0.001**	1 Meg, 50 uuf

\*These ranges are obtained by using Null ranges with all five voltage readout dials set to 0.

\*\*These ranges are obtained by the proper setting of the range and null switches with all five voltage readout dials set to 0.

GENERAL SPECIFICATIONS

REGULATION AND STABILITY OF 500 VOLT SUPPLY:

- ±0.0025% for a ±10% line change
- ±0.005% per hour after 30 min. warmup

STABILITY OF METER ZERO:

- ±0.25% of full scale for a ±10% line change

TERMINAL LINEARITY OF KELVIN-VARLEY DIVIDER:

- ±0.0005% (5 ppm) from 0 to 0.1 of full scale
- ±0.0005% to ±0.005% (5 ppm to 50 ppm) from 0.1 full scale to full scale

OPERATING TEMPERATURE RANGE:

- Model 803D (Standard cell reference element)
- Within DC accuracy specifications from 55°F to 95°F, derated at 0.001%/°F outside these limits to 35°F and 110°F

- Within AC accuracy specifications from 55°F to 95°F, derated outside these limits to 35°F and 110°F as follows:

- ±0.003%/°F up to 10 kcps
- ±0.005%/°F above 10 kcps

Model 803D/AG (Zener diode reference element)

- Within DC accuracy specifications from 55°F to 95°F, derated at 0.001%/°F outside these limits to 0°F and 125°F

- Within AC accuracy specifications from 55°F to 95°F, derated outside these limits to 0°F and 125°F as follows:

- ±0.003%/°F up to 10 kcps
- ±0.005%/°F above 10 kcps

RELATIVE HUMIDITY:

- Within specifications from 0 to 80% relative humidity

SHOCK AND VIBRATION:

- Meets requirements of MIL-T-945A

INPUT POWER:

- 115/230 VAC ±10%, 50 - 400 cps,
- 80 watts (803D), 85 watts (803D/AG)

SIZE:

- Cabinet: 13" high x 9-1/2" wide x 16" deep
- Rack: 7" high x 19" wide x 15-1/2" deep

WEIGHT:

- Cabinet: Approximately 28 lbs.
- Rack: Approximately 26 lbs.

SECTION II  
OPERATING INSTRUCTIONS

2-1. CONTROLS, TERMINALS, AND INDICATORS

The location, circuit symbol, and a functional description of external controls, terminals, and indicators on the 803D

Precision AC/DC Differential Voltmeter may be found in figure 2-1.

CONTROLS TERMINALS AND INDICATORS	LOCATION	CIRCUIT SYMBOL	FUNCTION DESCRIPTION
Input terminals	Front panel	J1, J2	Provided for connecting AC or DC voltage to be measured.
Chassis ground terminal	Front panel	J3	Provided for grounding purposes. A 0.47 uf capacitor is connected from the lower input binding post to the chassis ground post. The upper input post should never be connected to the chassis ground post. Since the instrument is equipped with a three-wire line cord with the third wire fastened to the chassis, the external circuit should be checked for conflicts in grounding before connecting lower input binding post (middle post) to the chassis post.
Power toggle switch	Front panel	S1	Applies AC line voltage to the primary circuit of the power transformer.
OPERATE-CALIBRATE switch	Front panel	S4	Remains in the OPERATE position at all times except when it is necessary to calibrate the internal 500 volt DC reference supply. When held in the CALIBRATE position, a representative sample of the reference voltage is compared to the voltage of an internal standard cell, or Zener reference diode for the /AG models, and any difference is indicated on the meter.
CALIBRATE control	Front panel	R2	Varies the output of the 500 volt DC reference supply. When the OPERATE-CALIBRATE switch is held in the CALIBRATE position, the reference supply is accurately set by adjusting the CALIBRATE control for zero meter deflection.
RANGE switch	Front panel	S2	Select desired voltage range. Full scale voltage ranges of 500, 50, 5, and 0.5 volts are available. It also indicates the AC NULL MULT for each range position.

Figure 2-1. CONTROLS, TERMINALS, AND INDICATORS (sheet 1 of 2)

CONTROLS TERMINALS AND INDICATORS	LOCATION	CIRCUIT SYMBOL	FUNCTIONAL DESCRIPTION
NULL switch	Front panel	S3	Set to VTVM for determining the approximate value of unknown voltage prior to differential measurements. Five null switch ranges of 10, 1, 0.1, 0.01, and 0.001 volts are used for differential measurements. For the DC mode, the null ranges represent full scale differences between the unknown voltage and the amount of precision internal reference voltage that is set on the voltage readout dials. For the AC mode, the <u>null range</u> used <u>times</u> the applicable <u>AC Null Multiplier</u> , indicated by the range switch, <u>represents the full scale difference</u> between the unknown voltage and the amount set on the voltage dials.
A, B, C, D, and E voltage readout dials	Front panel	S6, S7, S8, S9, S10	Provide an in-line readout of the amount of internal reference voltage necessary to null the unknown voltage.
Decimal lights	Front panel	DS1, DS2, DS3, DS4	Serve as decimal points for the voltage readout dials. A different light illuminates for each position of the RANGE switch.
AC - DC polarity switch	Front panel	S5	Selects the AC, + DC, or - DC mode of operation. With this switch in the positive position, the polarity of the upper input binding post is positive with respect to the lower input binding post (middle post).
Output terminals	Rear panel of cabinet models, front panel of rack models.	J4, J5	Provided for attaching a recorder to monitor voltage excursions.
Output level control	Rear panel of cabinet models, front panel of rack models.	R1	Varies the output level of the output binding post from 0 to at least 18 millivolts full scale deflection.
Meter	Front panel	M1	Indicates approximate voltage when 803D is in VTVM mode and difference between unknown and internal reference voltage when 803D is in differential mode. The upper scale, 500-0-500, is used when the NULL switch is set to VTVM at all other times, the lower scale, 1-0-1, is used.
Mechanical zero control	Meter case	None	Sets meter to zero mechanically. This adjustment should be used only after instrument has been turned off for at least three minutes or when the internal meter terminals have been shorted.
Fuse	Rear panel of cabinet models front panel of rack models.	F1	Fuse holder protrudes from instrument to provide easy access to the fuse. The fuse is a 1.5 ampere slow blowing type for 115 volt operation and a 0.75 ampere slow blowing type for 230 volt operation.

Figure 2-1. CONTROLS, TERMINALS, AND INDICATORS (sheet 2 of 2)

## 2-2. ZEROING INSTRUCTIONS

From time to time, it may be necessary to adjust the internal meter zero control. This will normally be done at somewhat more frequent intervals than complete instrument calibration. Proceed as follows:

- a. Mechanically zero the meter with the adjustment screw on the front of the meter case. If the instrument is in the case, it must be shut off for at least three minutes prior to this adjustment. If out of case, another method would be to short out the internal meter terminals prior to zeroing.
- b. Set power switch to ON and allow a 20 minute warmup period.
- c. Set RANGE switch to 5 or 0.5 volts, voltage readout is to zero, and NULL switch to VTVM.
- d. Adjust R232, null detector ZERO ADJ, for zero meter deflection. This control may be reached through the ventilation holes in the cabinet model (see figure 4-3). In the rack model, an identified access hole is provided on the rear panel.

## 2-3. PRELIMINARY OPERATION

The following procedure prepares the voltmeter for operation:

- a. Connect power plug to a 115 volt AC power source. If instrument has been wired for 230 volt operation, connect to 230 volts AC.

### NOTE

**The round pin on polarized three-prong plug connects instrument case to power system ground. Use three-to-two pin adapter supplied with instrument when connecting to a two-contact receptacle. For personnel safety, connect short lead to a suitable ground.**

- b. Set controls on 803D voltmeter as follows:

RANGE	500 volts
NULL	VTVM
AC - DC polarity	+ (positive)
all voltage	0 (zero)
readout dials	
power	ON

- c. After a warmup period of at least ten minutes, advance OPERATE-CALIBRATE switch against spring tension to CALIBRATE, and adjust internal 500 volt DC reference supply with CALIBRATE control for zero meter deflection. Release OPERATE-CALIBRATE switch.

## 2-4. OPERATION AS A DC DIFFERENTIAL VOLTMETER

- a. After completing preliminary operation, connect unknown voltage to input binding posts. If one side is grounded, always connect it to the lower input post (middle post).

- b. Turn RANGE switch to lowest range that will allow an on-scale reading and note approximate value of unknown voltage as indicated on upper meter scale.

- c. If meter reads to the left, turn AC - DC polarity switch to the negative position. The meter needle will deflect to the light. This is because polarity of unknown voltage is negative.

- d. Noting the position of illuminated decimal light, set five voltage readout dials to approximate voltage determined in step b. For example, if approximate voltage is 35 volts, the decimal light between the B and C voltage readout dials will be illuminated. Therefore, set A dial to 3, B dial to 5, and C, D, and E dials to 0.

- e. Set NULL switch to successively more sensitive null ranges, as indicated in figure 2-2, and adjust voltage readout dials for zero meter deflection in each null position. When the meter needle indicates to the right, the voltage under measurement is greater than the voltage set on the voltage readout dials. When the indication is to the left, the voltage is less than that set on the readout dials.

- f. Read unknown voltage directly from the five voltage readout dials.

INPUT VOLTAGE RANGE	*RECOMMENDED NULL SETTING
50-500	10 then 1 (then 0.1 for voltages from 50 to 100 volts)
5-50	1 then 0.1 (then 0.01 for voltages from 5 to 10 volts)
0.5-5	0.1 then 0.01 (then 0.001 for voltages from 0.5 to 1 volt)
0-0.5	0.01 then 0.001

\*Any null range may be used with any input voltage range; recommended settings are those most useful.

Figure 2-2. RECOMMENDED NULL SETTINGS

## 2-5. OPERATION AS AN AC DIFFERENTIAL VOLTMETER

- a. After completing preliminary operation set AC-DC polarity switch to AC.

- b. Connect unknown AC voltage to input binding posts.

- c. Turn RANGE switch to lowest range that will allow an on-scale reading and note approximate value of unknown voltage as indicated on upper meter scale.

- d. Noting the position of illuminated decimal light, set five voltage dials to approximate voltage determined in step c. For example, if approximate voltage is 35 volts, the decimal light between the B and C voltage dials will be illuminated. Therefore, set A dial to 3, B dial to 5, and C, D, and E dials to 0.

- e. Set null switch to 0.1 and then 0.01 volt, adjusting voltage dials for zero meter deflection in each position.
- f. Read unknown voltage from the five voltage readout dials.

2-6. OPERATION AS A CONVENTIONAL VTVM

If it is desired to use the instrument as a VTVM on additional ranges can be made available by converting the NULL ranges to VTVM ranges. This is made possible by setting the voltage readout dials to zero. Proceed as follows:

- a. Perform preliminary operation procedures as stated in paragraph 2-3.
- b. Consult figure 2-3, and select full scale voltage deflection desired. If the approximate value of the voltage to be measured is unknown, select the 500 volt range initially.
- c. Set AC - DC polarity switch, RANGE switch, NULL switch, and voltage dials as indicated for the range selected.
- d. Connect voltage to be measured to input binding posts. Deflection to the right indicates that an unknown DC voltage is of positive polarity. An unknown AC voltage will always cause deflection to the right.
- e. Read voltage from upper or lower scale as listed in figure 2-3.

2-7. MEASUREMENT OF VOLTAGE EXCURSIONS ABOUT A NOMINAL VALUE

- a. After completing preliminary operation as stated in paragraph 2-3, set AC - DC polarity switch to desired position.
- b. Connect voltage to be observed to input binding posts. If meter reads to the left, the voltage being measured is negative DC; set polarity switch to the negative position in this case. This will cause meter pointer to defect to the right.
- c. Set RANGE switch to lowest range which will give an on-scale meter indication and note nominal value of voltage indicated.
- d. Set the five voltage readout dials to nominal voltage.
- e. Turn NULL switch to lowest position that will allow voltage excursions to remain on scale.
- f. Read voltage excursions from meter. Note that full scale right and left meter deflections are equal to the NULL voltage setting for DC measurements. For AC measurements, full scale right and left meter deflections are equal to the NULL voltage setting multiplied by the AC NULL MULT indicated by the RANGE setting. Figure 2-4 shows full scale AC deflections for the recommended settings of the range and null switches.

Full-Scale Deflection	AC-DC Polarity Switch	Range Switch	Null Switch	Voltage Readout Dials	Meter Scale
DC:					
500-0-500	+	500	VTVM	No effect	Upper
50-0-50	+	50	VTVM	No effect	Upper
5-0-5	+	5	VTVM	No effect	Upper
0.5-0-0.5	+	0.5	VTVM	No effect	Upper
10-0-10	+	No effect	10	All zero	Lower
1-0-1	+	No effect	1	All zero	Lower
0.1-0-0.1	+	No effect	0.1	All zero	Lower
0.01-0-0.01	+	No effect	0.01	All zero	Lower
0.001-0-0.001	+	No effect	0.001	All zero	Lower
AC:					
0-500	AC	500	VTVM	No effect	Upper
0-50	AC	50	VTVM	No effect	Upper
0-5	AC	5	VTVM	No effect	Upper
0-0.5	AC	0.5	VTVM	No effect	Upper
0-100	AC	500	1	All zero	Lower
0-10	AC	500	0.1	All zero	Lower
		50	1		
0-1	AC	500	0.01	All zero	Lower
		50	0.1		
		5	1		
0-0.1	AC	50	0.01	All zero	Lower
		5	0.1		
		0.5	1		
0-0.01	AC	5	0.01	All zero	Lower
		0.5	0.1		
0-0.001	AC	0.5	0.01	All zero	Lower

Figure 2-3. VTVM RANGES

Range Switch Setting	Null Switch Setting	AC Null Multiplier	Full Scale AC Deflection (in volts)
500	1	X100	100
	0.1		10
	0.01		1
50	1	X10	10
	0.1		1
	0.01		0.1
5	1	X1	1
	0.1		0.1
	0.01		0.01
0.5	1	X0.1	0.1
	0.1		0.01
	0.01		0.001

Figure 2-4. FULL SCALE AC DEFLECTIONS

2-8. USE OF 803D WITH A RECORDER

Recorder output binding posts and an output level control are provided on the 803D for monitoring the excursions of an unknown voltage from the voltage indicated by the voltage dial settings. If the leakage resistance between the recorder and ground is less than 10,000 megohms, the accuracy of the 803D will be impaired. Also, both input posts of the recorder should be able to stand 500 volts DC to ground. Therefore, the John Fluke Model A-70 Potentiometric Recorder (manufactured by the Texas Instrument Co.) is recommended for this application. Set the recorder as follows:

a. Connect A-70 recorder to 803D voltmeter with teflon leads as shown in figure 2-5.

b. After connecting the recorder, perform preliminary operation as stated in paragraph 2-3.

c. Check for excessive leakage as follows:

(1) Connect a DC voltage to the input of the 803D and differentially measure its potential in a recommended null range.

(2) Alternately connect and disconnect the recorder leads from the output terminals of the 803D while noting the meter needle deflection. More than one-quarter of a small scale division deflection indicates that excessive leakage has been introduced by the recorder. This will impair the accuracy of the 803D voltmeter.

(3) Disconnect the voltage.

d. After the leakage test has been successfully completed, short the input terminals of the 803D.

e. Set switches on the 803D voltmeter as follows:

AC - DC polarity	+ (positive)
RANGE	50
NULL	10
Voltage readout dials	10.000

The 803D meter will indicate full scale deflection. This provides up to at least 18 millivolts at the output terminals depending on the setting of the output level control.

f. Turn the output level control until the recorder deflection obtained is that desired to correspond to full scale deflection of the 803D.

g. Remove the short from the input terminals of the 803D. The 803D and the recorder are now ready for combined use. Proceed as instructed under paragraph 2-7.

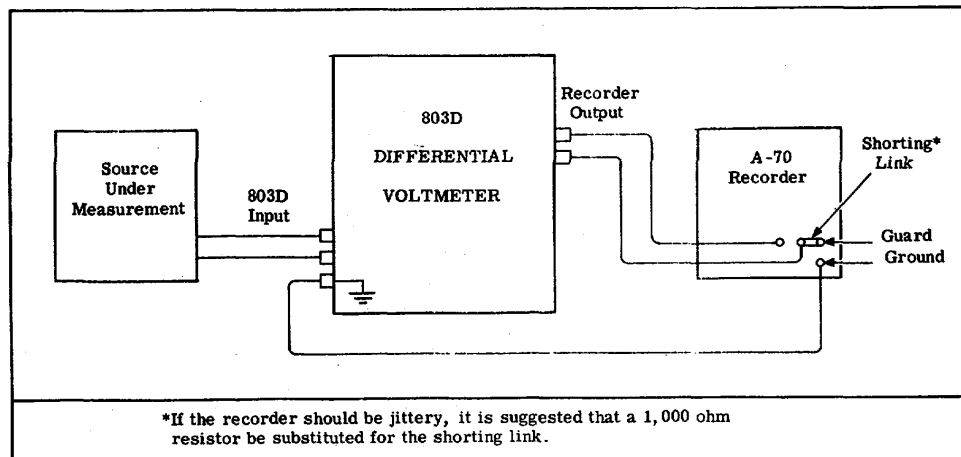

Figure 2-5. RECORDER RECOMMENDED CONNECTION DIAGRAM



## 2-9. MEASUREMENT OF HIGH RESISTANCES

One of the important features of the 803D voltmeter is its ability to be used as a megohmmeter for rapidly measuring high resistances from 1 megohm to 250,000 megohms. The following equation may be used to compute the resistance in megohms of an unknown connected to the input binding posts:

$$R_x = \frac{10(E - 1)}{E_m} \text{ megohms,}$$

where:

$R_x$	=	unknown resistance in megohms
$E$	=	voltage indicated by voltage readout dials
$E_m$	=	voltage indicated on meter
10	=	megohms of input resistance of VTVM circuit on 10, 1, and 0.1 null range.

When connecting the unknown resistance to the input terminals, use short isolated leads to prevent measuring leakage resistance between the leads.

a. FROM 1 MEGOHM TO 500 MEGOHMS. For rapid measurement of resistances from 1 megohm to 500 megohms, proceed as follows:

- (1) Perform preliminary procedure as stated in paragraph 2-3.
- (2) Set RANGE switch to 500 and NULL switch to 10.
- (3) Connect unknown resistance between input terminals.
- (4) Adjust voltage readout dials for full scale meter deflection.
- (5) Subtract 10.00 from the amount set on the voltage readout dials to find the resistance of the unknown in megohms.

b. FROM 500 MEGOHMS TO 5,000 MEGOHMS. For rapid measurement of resistances from 500 to 5,000 megohms, proceed as follows:

- (1) Perform preliminary procedure as stated in paragraph 2-3.
- (2) Set RANGE switch to 500 and NULL switch to 1.
- (3) Connect unknown resistance between input terminals.
- (4) Adjust voltage readout dials for full scale meter deflection.
- (5) Subtract 1.00 from the amount set on the voltage readout dials and multiply the result by 10 to find the resistance of the unknown in megohms.

c. FROM 5,000 MEGOHMS TO 50,000 MEGOHMS. For rapid measurement of resistances from 5,000 to 50,000 megohms, proceed as follows:

- (1) Perform preliminary procedure as stated in paragraph 2-3.
- (2) Set RANGE switch to 500 and NULL switch to 0.1.
- (3) Connect unknown resistance between input terminals.
- (4) Adjust voltage readout dials for full scale meter

deflection.

(5) Multiply the amount set on the voltage readout dials by 100 to find the resistance of the unknown in megohms.

d. FROM 50,000 MEGOHMS TO 250,000 MEGOHMS. To determine the value of an unknown resistance between 50,000 megohms and 250,000 megohms, proceed as follows:

- (1) Perform preliminary procedure as stated in paragraph 2-3.
- (2) Set RANGE switch to 500 and NULL switch to 0.1.
- (3) Connect unknown resistance between input terminals.
- (4) Adjust voltage readout dials for a convenient meter deflection.
- (5) The resistance in megohms may be calculated by substituting the meter reading in volts ( $E_m$ , 0 to 0.1 volt on bottom scale) and this voltage readout dial setting ( $E$ ) into the following equation:

$$R_x = \frac{10 E}{E_m} \text{ Megohms}$$

## 2-10. NOTES ON MEASURING AC OR DC VOLTAGES

a. ADJUSTMENT OF 500 VOLT REFERENCE SUPPLY. The 500 volt DC reference supply may be adjusted (paragraph 2-3, step c) at any time deemed necessary without heed to the position of the switches and without removing any input or output connections. However, until the instrument has warmed up to an equilibrium temperature (about 1/2 hour), it should be adjusted prior to each specific measurement for best accuracy. When making prolonged measurements, allow one hour warmup time to insure that 500 volt reference supply does not shift during the final warmup phase.

b. GROUND LOOP PRECAUTIONS. Ground loop currents should be avoided to assure accuracy when making measurements. Potential differences are often found at different points on power system grounds. When this is the case, current may flow from the power system ground through the 803D and the equipment under measurement and back to the power system ground. To avoid this when system being measured is grounded, do not connect shorting link from lower input binding post to chassis ground post.

c. USE OF SHORTING LINK. A 0.47 uf capacitor (C1) is connected from the lower input binding post to the chassis ground post to reduce the effect of circulating AC currents from the transformer. In some cases, it is possible for C1 to acquire a charge. For example, C1 will become charged through leakage resistance over a period of time if there is no external connection to the input terminals and the controls are set as follows: range to 500, null to any null range, polarity to +, and voltage readout dials to several hundred volts. This condition may cause an error on low level measurements (under 5 volts) due to C1 discharging through the Kelvin-Varley divider. Connecting the shorting link from the lower input post to the ground post will discharge C1 and thus prevent an inaccurate indication.

2-11. NOTES ON MEASURING DC VOLTAGES

a. RECOMMENDED NULL RANGES FOR DC MEASUREMENTS. Certain null ranges are recommended for use with each setting of the RANGE switch for the following reasons. With the RANGE switch at 500 volts the last voltage readout dial (E) changes the reference voltage in steps of 0.01 volt. Therefore, the unknown voltage would have to be an exact multiple of 0.01 volt if a null is to be obtained on the 0.1 or 0.01 volt NULL range. Furthermore, it is unlikely that an unknown voltage of a few hundred volts will be stable within 10 millivolts. Finally, the regulation of the reference supply is approximately  $\pm 0.0025\%$  ( $\pm 0.0125$  volt) for a 10% change in line voltage. Although this is more than adequate when the instrument is used in the recommended way, a badly fluctuating line voltage may cause the 803D to meter the regulation of its own 500 volt reference supply. For example, when measuring 500 volts a line change of 10% may cause the 500 volt reference supply to change as much as 12.5 mv. Although this is small, the 803D will indicate full scale for a change as little as 100 mv or 10 mv if attempting to use the 0.1 or 0.01 null ranges.

b. EFFECT OF AC COMPONENTS ON DC MEASUREMENTS. An AC component of several times the unknown DC may be present on the unknown and the 803D will always indicate well within the specifications for frequencies over a few hundred cycles. An AC component may have an adverse effect if it is of a low frequency or if it has a frequency that is a multiple or submultiple of the chopper frequency. A double section low pass filter (R201, C201, R202, and C202) is used at the input of the null detector to reduce any AC present on the DC being measured. At lower frequencies, this low pass filter is less effective and the magnitude of the AC component is more significant. If this frequency is below 100 cycles, the accuracy may no longer be with specifications. For example, a 60 cycle AC voltage that is 10% of the input voltage will cause an error of approximately 0.01% which is well within the specifications. Also, since the input attenuation is less for the more sensitive null settings, the accuracy may be affected only on the more sensitive null settings. When the frequency is very close to a multiple or submultiple of the chopper frequency (approximately 83 cycles), the meter needle will oscillate at the difference frequency. If AC components that affect the accuracy are ever encountered, additional filtering will be required. For an AC of a single frequency, a twin-T filter is effective and has the advantage of low total series resistance. For an AC variable frequency, an ordinary low pass filter may be used. In either case, high quality capacitors of high leakage resistance should be used.

c. MEASUREMENT OF NEGATIVE DC VOLTAGES. Because of a polarity switch, voltages which are negative with respect to ground as well as the more commonly encountered positive voltages may be measured with equal facility. If the upper input post is connected to the metal case or line ground, either at the 803D or at the source under measurement, the

accuracy of the voltmeter may be reduced. However, with the polarity switch the upper input post never has to be connected to ground. If the unknown voltage is grounded, always connect the grounded side to the lower input post (middle post) and use the polarity switch to obtain the proper result.

2-12. NOTES ON MEASURING AC VOLTAGES

a. ERRORS DUE TO DISTORTION. The AC to DC converter in the 803D is an average measuring device calibrated in RMS. The converter will put out a DC voltage that is proportional to 1.11 times the average value of the AC input voltage. Thus, if the input signal is not a true sinusoid, the 803D reading is probably in error because the ratio of RMS to average is usually not the same in a complex wave as in a sine wave. The magnitude of the error is dependent on magnitude of the distortion and on its phase and harmonic relationship with respect to the fundamental. Figure 2-6 indicates how the accuracy will be affected by various harmonics for different percentages of distortion. If the distortion present in the signal is composed of even harmonics and is less than 2%, the error between the 803D reading and true RMS is fairly minor. A larger error can occur if the distortion is composed of odd harmonics, especially the third harmonic. Note that for 2% of third harmonic distortion the error in the reading could range from 0 to 0.687%.

Harmonic	% Distortion	% Error From True RMS*	
		Maximum Positive	Maximum Negative
Any even harmonic	0.1	0.000	0.000
	0.5	0.000	0.0001
	1.0	0.000	0.005
	2.0	0.000	0.020
Third harmonic	0.1	0.033	0.033
	0.5	0.167	0.168
	1.0	0.328	0.338
Fifth harmonic	0.1	0.020	0.020
	0.5	0.099	0.101
	1.0	0.195	0.205
	2.0	0.380	0.420

\*Error depends upon phase relationship between harmonic and fundamental, i.e. error can be any value between maximum positive and maximum negative, including zero.

Figure 2-6. PERCENT ERROR DUE TO HARMONIC DISTORTION

b. ERRORS DUE TO GROUNDING. In the 803D there is a 0.47 uf capacitor connected from the lower input terminal (middle post) to chassis ground. If it is desired to make measurements where the voltage to be connected to the lower input terminal is not at ground potential, a line cord adapter must be used to isolate the 803D chassis from line ground. Otherwise, the 0.47 uf capacitor would place an AC load on the circuit being measured.

c. INTERNAL CONVERTER NOISE. When the instrument is shorted in the AC mode, the converter may produce a residual noise output of approximately 100 uv. This noise voltage will cause an insignificant error as long as AC input signals of 1 mv or larger are applied to the instrument. Figure 2-7 shows a typical half wave of the signal voltage at the output of the converter amplifier. It is easily seen that the noise contributes very little to the average value of the signal and is well within the 2.6% accuracy of the instrument at 1 mv.

d. 0.001 VOLT NULL RANGE - DC ONLY. The 0.001 volt null range is not recommended for use when measuring AC voltages for several reasons. One reason is that most AC sources are not stable enough. For example, if 0.5 volt is measured with the range set to 0.5 and the null switch set to 0.001, the effective null detector sensitivity is 100 microvolts full scale. Since 100 uv is 0.02% of 0.5 volts, an AC source with a stability worse than 400 parts per million will cause the 803D meter pointer to swing from one end of the meter to the other. Another reason for not using the 0.001



Figure 2-7. SIGNAL VOLTAGE WITH CONVERTER NOISE

volt null range for AC is the converter noise discussed in paragraph 2-12c. This noise will cause the meter pointer to move about erratically on the 0.001 volt null range. Although it is difficult to determine how much pointer movement is due to converter noise and how much is due to AC source stability, the AC source stability is usually the major source of erratic movement.

SECTION III

THEORY OF OPERATIONS

3-1. GENERAL

a. Figure 3-1 shows the block diagram for the 803D AC/DC Differential Voltmeter. As seen in this figure, the circuit consists basically of an AC to DC converter, a DC vacuum tube voltmeter (vtvm), and a 0 to 500 volt DC reference supply. Refer to the functional schematic following section VI for more detail. This schematic is designed to aid in the understanding of circuit theory and troubleshooting. The signal flow is from left to right and the components are laid out in a functionally logical manner.

b. The overall operation of the 803D may be summarized as follows. To measure the approximate value of a DC voltage, the unknown voltage is connected directly to the DC vtm. To accurately measure a DC voltage, the unknown voltage is connected across the series combination of the DC vtm and the 0 to 500 volt DC reference supply. The reference supply voltage is then adjusted with the five voltage readout

dials until it matches the unknown voltage as indicated by the vtm. All AC measurements are made by first converting the AC input voltage to a DC voltage by means of the AC to DC converter. The 803D then operates essentially the same as for approximate and accurate DC measurements.

c. In order to provide for a more complete understanding of the 803D voltmeter, the following paragraphs describe each section of the circuit in detail.

3-2. DC VACUUM TUBE VOLTMETER

a. GENERAL. The DC vtm is composed of an attenuator, a null detector, and a meter. The heart of the DC vtm is the null detector in which the DC signal input is modulated by an electromechanical chopper, amplified by a convention four stage resistance-capacitance coupled amplifier, rectified by the chopper, and

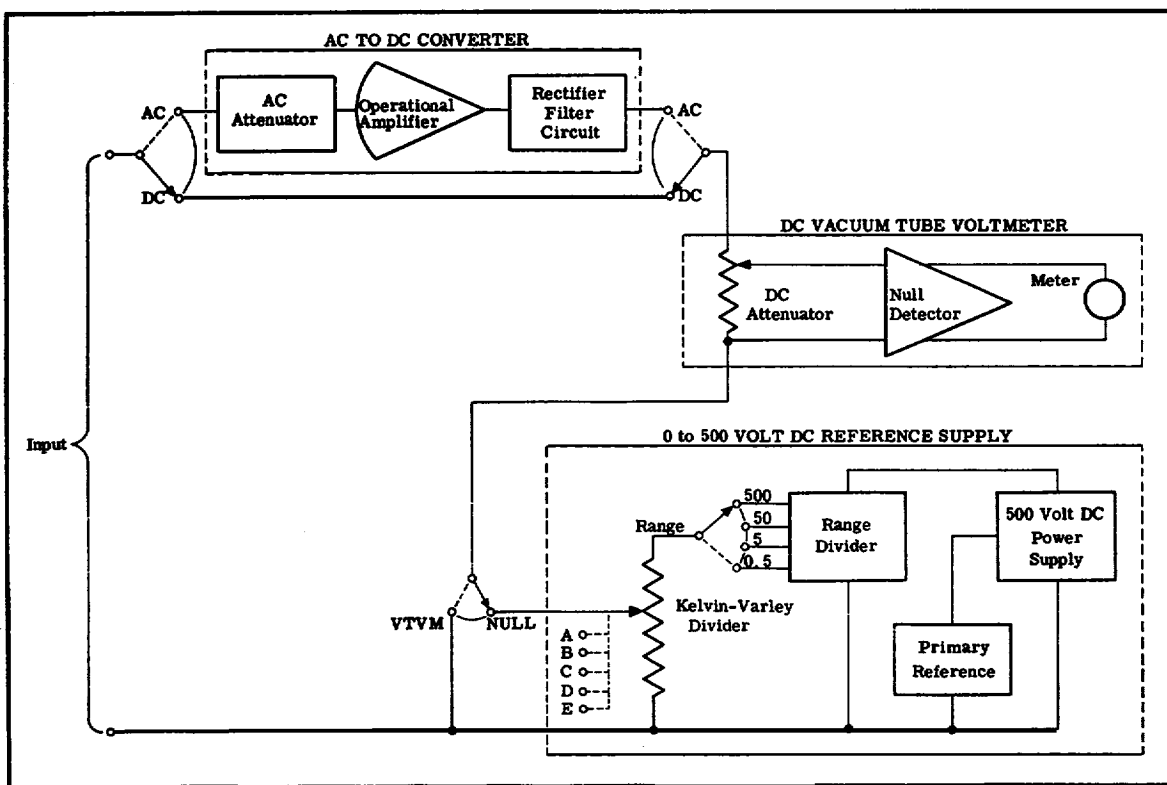

Figure 3-1. 803D AC/DC DIFFERENTIAL VOLTMETER BLOCK DIAGRAM

finally filtered to produce a DC output. The chopper amplifier has a high amount of negative current feedback. This makes the output current approximately equal to the signal voltage divided by the impedance of the feedback network, regardless of the amplifier characteristics. The high negative feedback also makes the amplifier relatively insensitive to the gain changes in individual tubes due to aging and replacement. The output current from the null detector is indicated on a meter that has taut-band suspension. This suspension does away with a friction associated with meter pivot stickiness. Thus, any tendency for the meter pointer to stick at one point of the scale and then jump to another point is completely eliminated. The attenuator is used to reduce the voltage span of each range to a common range usable by the chopper amplifier to produce proper meter deflection.

b. NULL DETECTOR. At the input to the null detector, R201, C201, R202, and C202 form a double section low pass filter that reduces any AC component present on the DC voltage being measured. The difference between the voltage appearing at the output of the filter and the voltage developed across the feedback network is converted to an alternating voltage by G1, an 83 cycle chopper. This chopped voltage is amplified by V202A, V202B, and V03A before passing through cathode follower V203B. During half the chopper cycle the output of the amplifier is clamped to approximate null detector common potential by G1 while during the other half the output is filtered by C212 to provide a DC current for the meter. The voltage developed across feedback network R220, R221, and R222 is proportional to the meter (output current. When the chopper provides connection between contacts 5 and 7, this feedback voltage effectively reduces the magnitude of the voltage that is chopped and applied to the input of the amplifier. The impedance of the feedback network (R220, R221, and R222) is adjustable between 8.82 and 9.83 ohms. Since the output current is approximately equal to the signal voltage divided by the impedance of the feedback network, a 1 mv signal voltage indicates an output current of 101.7 to 113.4 ua. However, there is a loss due to finite amplifier gain and filtering that leaves the output current around 100 ua which can be set accurately by means of the feedback network. Thus, current feedback makes the output current essentially proportional to the signal voltage. For full scale deflection, a 1 mv signal voltage will cause 100 ua to flow through the meter.

c. INPUT ATTENUATOR. In the DC vtm mode, four positions on the vtm attenuator selected by range switch section S2C provide the necessary reduction of the 500, 50, 5, and 0.5 volt ranges for proper chopper-amplifier input. For this mode, the resistance of the attenuator and thus the input resistance of the 803D is 50 megohms (R301 through R310). In the DC differential mode, the voltage difference (unknown voltage minus reference voltage) is reduced by four positions on the vtm attenuator selected by null switch sections S3C and S3D to give full scale deflections corresponding to inputs of 10, 1, 0.1, and 0.01 volts. For full scale deflection corresponding to 0.001 volt, the voltage across the attenuator is fed directly to the chopper amplifier. Although the resistance of the vtm attenuator is 10 megohms (R305 through R310) for the 10, 1, 0.1, and 0.01 volt null ranges and 1 megohm (R306

through R310) for the 0.001 volt null range; this is not the input resistance of the 803D. The input resistance is determined by dividing the unknown terminal voltage by the current drawn from the unknown. The current drawn from the unknown is equal to the difference between the unknown terminal voltage and the internally known voltage divided by the resistance of the input attenuator. The equation for input resistance can be hence written as:

$$R_{in} = \frac{E_U}{I_U} = \frac{E_U R_a}{|E_U - E|} = \frac{E_S (R_a + R_S)}{|E_S - E|} - R_S \text{ where:}$$

- $R_{in}$  = input resistance of voltmeter
- $E_U$  =  $E_S - I_U R_S$  = terminal voltage of unknown
- $I_U$  = current drawn from unknown
- $E_S$  = source voltage of unknown
- $R_S$  = source resistance of unknown
- $R_a$  = resistance of input attenuator
- $E$  = voltage indicated by voltage readout dials
- $| |$  = absolute value (magnitude only)

Since the reference voltage (E) is equal to the unknown voltage ( $E_U$ ) and the source voltage ( $E_S$ ) at null, no current is drawn from the unknown and the input resistance is therefore infinite.

d. In the AC vtm mode, null switch sections S3C and S3D and AC - DC switch section S5E provide connection to only one position on the vtm attenuator regardless of where the range switch is set. This is because the output of the AC to DC converter is 5 volts DC for full input on each range. In the AC differential mode, the voltage difference (converter output voltage minus reference voltage) is reduced by the same positions on the vtm attenuator as for DC differential measurements. Because of this and the fact that the converter puts out 5 volts DC for full input on each range, the null range used must be multiplied by the AC null multiplier indicated by the range switch to find the full scale difference between the unknown voltage and the reference voltage. The input impedance for the AC vtm and AC differential mode depends on the input impedance of the AC to DC converter and its attenuator. The input impedance is thus dependent on the setting of the range switch and is 1 megohm 35 uuf for the 500 volt AC range, 1.1 megohm 35 uuf for the 50 volt AC range, and 1 megohm 50 uuf for the 5 and 0.5 volt AC ranges.

e. NULL DETECTOR POWER SUPPLY. The B+ supply for the null detector is obtained from a half-wave rectifier consisting of diode CR201 and a filter network (C213A, R227, and C213B) that is regulated by an OA2 tube (V204) and series dropping resistor R230. Divider resistors R228, R229, R231, and R232 and diode CR202 provide a compensating voltage for the purpose of adjusting the null detector to zero with R232 when there is no signal input. Diode CR202 keeps one side of R232 at approximately -0.6 volts DC with respect to the null detector common.

f. The filament of V202 and the chopper drive unit require a stable supply. This is obtained by using a filtered half-wave rectifier (CR203 and C214) that drives a Darlington connection of Q201 and Q202. A divider string R234 and R235 uses the B+ supply to obtain approximately 11.8 volts for pin-5 of V202 while pin-4 is maintained approximately 0 volts through the emitter-base junctions of Q201 and Q202. Any change in the half-wave rectifier voltage causes a corresponding change in the voltage across the emitter-collector junction of Q201 so that the filament and chopper voltage remain stable. The filament supply for V203 obtained from an ordinary 6.3 volt AC winding.

g. EFFECT OF AC COMPONENTS. The only AC voltage component that will reduce the accuracy of the 803D is one that either saturates the chopper amplifier or one that beats with the chopper frequency. Since the voltage required for saturation is greater than that required for beating, the null detector is most sensitive to an AC component with a frequency that is a submultiple or a low multiple of the chopper frequency. However, this is easy to detect because the meter will beat at the difference frequency. The low pass filter at the input of the chopper amplifier will attenuate any AC component. The magnitude of the AC voltage appearing at the output of the filter depends on both its amplitude and frequency before filtering. For all practical purposes, one should never encounter any trouble above a hundred cycles. Below this, the filter may not attenuate the AC component enough. However, this is not as bad as it appears. A 60 cycle AC voltage that is 10% of the input voltage will cause an error of approximately 0.01% which is well within specifications. If AC components that affect accuracy are ever encountered, additional filtering as set forth in paragraph 2-11 will eliminate the problem.

h. GAIN AND ZERO ADJUSTMENTS. Variable resistor R232 in the null detector power supply provides a means of adjusting the output current of the amplifier to zero when there is no input signal. The gain of the amplifier is adjusted by means of R222 in the feedback circuit.

i. RECORDER OUTPUT. The recorder output is picked off divider string R225, R1, and R226. Output level control R1 provides a means of adjusting the output voltage up to a maximum of at least 18 millivolts at full scale deflection. The voltage at the output terminals is proportional to the meter reading.

### 3-3. 0 TO 500 VOLT REFERENCE SUPPLY

a. GENERAL. When the 803D is used for differential voltage measurements, an internal voltage is nulled or matched against the unknown voltage. An extremely accurate reference voltage is therefore required. This is obtained from the 0 to 500 volt reference supply. The 0 to 500 volt reference supply is composed of a well regulated 500 volt power supply, a range divider and a Kelvin-Varley five decade attenuator. The output of the 500 volt power supply is applied directly to the Kelvin-Varley attenuator for the 500 volt DC range. In the 50, 5, and 0.5 volt DC ranges, the range divider reduces the voltage to 50, 5, and 0.5 volts before it is applied to the Kelvin-Varley attenuator. For any AC range, the range divider always

reduces the voltage to 5 volts. The Kelvin-Varley attenuator divides its input voltage (500, 50, 5, or 0.5 volts) into 50,000 equal increments any number of which may be selected by setting the five decades with the voltage readout dials. The output of the Kelvin-Varley Attenuator, therefore, provides an extremely accurate reference voltage.

b. 500 VOLT POWER SUPPLY. The 500 volt power supply uses three diodes (CR101, CR102, and CR103) and a filter network (R109, R110, C101, and C102) to supply unregulated DC voltage to series passing tube V101. The voltage is regulated by comparing a sample of the output voltage tapped off a divider string (R123, R124, R121, and R2) with the voltage from reference tube V102 in differential amplifier V104. The output of V104 is fed to differential amplifier V105 which drives the grid of series passing tube V101. The control action of the differential amplifiers continuously adjusts the voltage drop across the series passing tube so as to keep the sample voltage equal to the voltage of the reference tube. Any difference in voltage, the error, is amplified by V104 and V105 and thus changes the voltage drop across V101 to maintain the output at 500 volts.

c. For proper operation a highly stable and accurate balance of amplification must be maintained between the two halves of differential amplifier V104. The filament supply for V104 must be regulated to maintain this balance. Regulation is provided by a transistor regulator which supplies constant voltage to the filament of V104. The filaments of the AC to DC converter tubes (V501 and V502) are also supplied by this regulator. A filtered full wave rectifier (CR104, CR105, and C103) which is regulated by a three transistor network (Q1, Q2, and Q3) supplies the regulated DC filament voltage. One side of the filaments are connected to the reference supply common (0 volts) while the other side is maintained at approximately 5.9 volts through the emitter-collector junction of Q3. The output of Q1 drives a Darlington connection of Q2 and Q3. Any variation in the unregulated supply causes a corresponding change in the voltage across the emitter-collector junction of Q3 so that the filament voltage of V104, V501, and V502 remains stable.

d. RANGE DIVIDER. In the 500 volt DC range the output of the 500 volt supply is passed directly to the Kelvin-Varley attenuator by range section S2F. In the 50, 5, and 0.5 volt DC positions, range resistors (R320 through R330) selected by section S2E divide the reference voltage to 50, 5, and 0.5 volts before it is switched to the Kelvin-Varley attenuator by section S2F. With the AC - DC switch set to AC, AC - DC switch section S5E provides connection to the range resistors that divide the reference to 5 volts. This 5 volts is then passed to the Kelvin-Varley attenuator by section S5D. The voltage applied to the Kelvin-Varley attenuator is always 5 volts for AC because the AC to DC converter always supplies up to a maximum of 5 volts to the vtm attenuator.

e. KELVIN-VARLEY ATTENUATOR. The five Kelvin-Varley decade resistor strings R401 through R449 and associated voltage dials A through E (S6 through S10)

provide a means of making the four precision voltages (500, 50, 5, and 0.5) adjustable. Note that each string, with the exception of the first, parallels two resistors of the preceding string. Between the two wipers of S6 (voltage dial A) then, there is a total resistance of 40K (80K paralleled by 80K). With the range switch in the 500 volt position, a total voltage of 100 volts DC will appear across these two wipers. Also, there will be 10, 1, and 0.1 volts DC across the wipers of S7, S8, and S9, respectively. Voltage dial E (S10) picks increments of 0.01 volt DC from the last decade. These voltages are reduced by a factor of 10 for each lower voltage range. All resistors of each decade are matched and the three most critical decades (40K, 8K, and 1.6K are matched for each instrument, providing an overall accuracy of 0.005% absolute. With the null switch in any null range, the output of the Kelvin-Varley attenuator is connected in series with the vtm attenuator thus providing the accurate 0 to 500 volts reference supply required.

f. ADJUSTMENTS. Variable resistor R121 is used during calibration to set the 500 volt supply to 500 volts with calibrate control R2 set at its center of rotation. This allows the reference supply to be adjusted to 500 volts by means of the calibrate control at any time deemed necessary. With the operate-calibrate switch held at calibrate, a fixed percentage of the 500 volt supply is compared to the precise potential of an internal standard cell or Zener reference diode in the (AG models). Any difference in potential is fed to the null detector to give an indication on the meter so that the 500 volt supply can be set with the calibrate control. The fixed percentage of the reference supply is set accurately during calibration by means of R318. The 50, 5, and 0.5 volt range resistor networks are set accurately during calibration by means of R323, R326, and R329.

### 3-4. AC TO DC CONVERTER

a. GENERAL. The AC to DC converter is composed of an attenuator, an operational amplifier, and a rectifier-filter circuit. A diode in the rectifier-filter circuit is used to convert the unknown AC into pulsating DC, which is then filtered to obtain a DC voltage that is proportional to the average value of the AC input voltage. The output however, is calibrated to indicate the rms value of a pure sine wave. An operational amplifier containing three resistance-capacitance coupled amplifier stages with high negative feedback is used to make the rectification characteristics of the diodes linear and stable. The amplifier achieves a midband loop gain of approximately 70 db with a virtually flat frequency response from 20 cps to 10 kc. The high negative feedback makes the amplifier practically noise free and relatively insensitive to gain changes in individual tubes due to aging and tube replacement. At the output to the amplifier, full wave rectification is used to return negative feedback to the grid of the first amplifier tube. The attenuator is used to reduce the AC input voltage by a factor of 10 or 100, as required to restrict the operational amplifier input

to 5 volts maximum for full scale inputs of 50 and 500 volts respectively.

b. OPERATION. All AC measurements are made by first converting the AC input voltage to a DC voltage. The converter provides a DC output of 5 volts when full range voltage is applied to the 803D in each AC range. In the 5 volt AC position, range switch sections S2G and S2H connect the input binding posts directly to the converter input. In this case, the converter feedback is of such a value that the DC output voltage is equal to the rms value of the converter input AC voltage. In the 500 and 50 volt AC positions, an input attenuator reduces the unknown AC by a factor of 100 and 10 respectively. The operation of the converter is then the same as for the 5 volt position. In the 0.5 volt AC position, range switch section S2I and section S2J provide connection to feedback resistor that allow the converter to produce an output that equal to ten times the AC input. Thus, an output of 5 volts DC is provided for full scale input on any AC range.

c. NULL INDICATIONS. When making AC differential measurements, the null range used times the applicable AC null multiplier must be used to represent full scale on the 803D meter. This is due to the way that the converter is constructed. For the 500 volt AC range, the converter produces a DC output voltage equal to 1/100 of the AC input voltage. Thus, the AC null multiplier for the 500 volt range position is X100. For example, when the range switch is set to 500 and the null switch is set to 0.01, full scale meter deflection represents a one volt (100 x 0.01) difference between the unknown voltage and the amount set on the voltage readout dials. By similar reasoning, the multipliers for the 50, 5, and 0.5 volt AC ranges are X10, X1, and X0.1, respectively.

d. ADJUSTMENTS. For 0.5 volt converter gain, R536 and R545 at the output of the converter are adjusted. The gain of the amplifier for the 5 volt range is adjusted by means of R542 and R541 in the feedback network. The high frequency response of the amplifier input is adjusted by means of C504 while C519 adjusts the high frequency response of the 0.5 volt feedback circuit. The attenuation of the 500 volt attenuator is adjusted with R535 and R544 and the attenuator high frequency response is adjusted with C501. The attenuation of the 50 volt attenuator is adjusted with R503 and R533 and the attenuator high frequency response is adjusted with C523.

### 3-5. AC - DC POLARITY SWITCH

a. The AC - DC polarity switch is provided for selecting either the AC or DC mode of operation. When the AC - DC polarity switch is set to AC, the AC to DC converter is switched into the circuit by sections S5K, S5L, S5M, and S5N. Also, sections S5D and S5E are used to switch 5 volts DC to the Kelvin-Varley divider. When in the AC vtm mode, S5F is used to provide proper attenuation for the DC attenuator.

b. The AC - DC polarity switch may be set to either of two positions, positive or negative, for the DC mode of operation. As seen in figure 3-2, the AC - DC polarity switch does not reverse the input posts when going from the positive to negative DC position. It reverses the meter and the internal reference supply. If the instrument did not contain positive and negative DC positions, the grounded side of any unknown voltage that is negative with respect to ground would have to be connected to the upper input binding post. This would

ground the upper post and effectively place C1 (a 0.47 uf capacitor) across the input terminals. Even if C1 was disconnected, there would still be considerable capacitance across the input due to transformer wiring capacitance and stray wiring capacitance. With this capacitance across the circuit being measured several problems could arise. The polarity switch provides equal convenience in measuring positive or negative voltages without the occurrence of these problems.

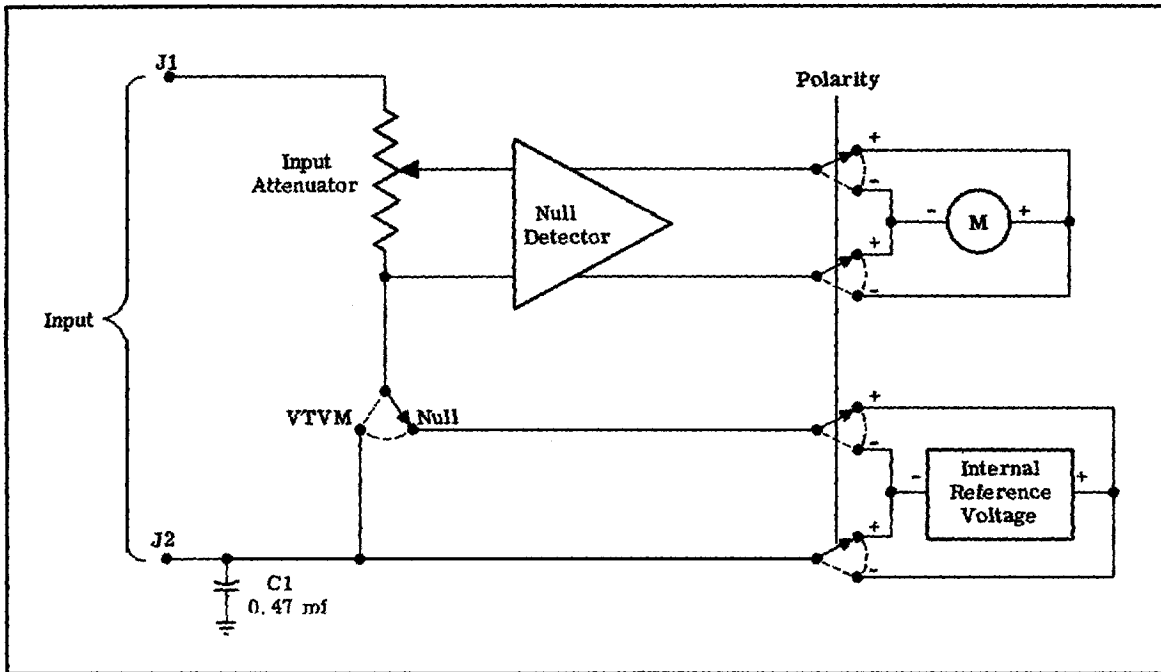

Figure 3-2. FUNCTION OF POLARITY SWITCH



**SECTION IV**  
**MAINTENANCE**

4-1. GENERAL

The 803D AC/DC Differential Voltmeter seldom requires any maintenance. Without extreme abuse, all that should be required is occasional cleaning, tube replacement and calibration. Periodic maintenance consists only of preventing any leakage as discussed in paragraph 4-2. A discussion of troubleshooting along with a troubleshooting chart, component location diagrams, and a tube voltage chart are provided in paragraph 4-3. Paragraph 4-4 delineates the equipment and procedures necessary to calibrate the instrument.

4-2. PERIODIC MAINTENANCE

a. The accuracy of the 803D is adversely affected by excessive electrical leakage from the input of the null detector to either ground or the 500 volt reference supply. Special care has been taken to prevent leakage across certain critical switch wafers and areas of some printed circuit boards due to moisture from condensation. The printed circuit boards have been coated with Humi-Seal 1B12. The range, null, operate-calibrate, and polarity switches have been dipped in Dow Corning silicone oil. Accumulations of dust and foreign matter will cause internal leakage, and should be removed as often as necessary, depending on environmental operating conditions.

b. To check for excessive electrical leakage, proceed as follows:

(1) Perform preliminary operation procedure as stated in paragraph 2-3.

(2) Set switches on 803D as follows:

RANGE	500
NULL	0.1
voltage read- out dials	490.00

(3) Remove test leads from input posts.

(4) Excessive leakage is indicated if the meter deflects more than one-tenth of full scale.

c. To prevent excessive electrical leakage, proceed as follows:

(1) Blow the instrument out with low-pressure, clean, dry air to remove most accumulations of dust and foreign matter. Pay particular attention to the binding posts, binding post wiring, critical switches (NULL, RANGE, OPERATE-CALIBRATE, and polarity switches), and the two glass epoxy strips which insulate the null detector chassis from the main chassis.

(2) Clean the glass epoxy strip, binding posts, insulators, and front panel with a rag saturated in anhydrous denatured ethyl alcohol.

(3) When necessary, wash all exposed dielectric surfaces of the NULL, RANGE, OPERATE-CALIBRATE, and polarity switches with denatured alcohol using a small, stiff-bristled brush.

**CAUTION**

**Do not use Metriclene, acetone, lacquer thinner, or any other methyl ethyl ketones, since they will react with the Lexan rotor on the CTS plastic switches.**

(4) After washing, recoat the exposed switch insulating material with a solution of Dow Corning 200 having a viscosity between 5 and 20 centistokes. This prevents leakage due to moisture on these surfaces.

4-3. CORRECTIVE MAINTENANCE

a. TROUBLESHOOTING. The purpose of troubleshooting is to quickly and accurately determine the cause of any abnormal condition. To assist in localizing most troubles which might occur, the causes and remedies for a number of symptoms are listed in the troubleshooting chart (figure 4-1). Since failure of the 803D is usually due to tube failure, it is recommended that the substitution be tried before any other tests are made. However, the 803D is conservatively designed and should require very infrequent tube replacement. At certain times, a check of the pin voltages in the tubes (figure 4-2) is also useful. As an aid to troubleshooting, all components may be located by referring to the figures shown in section V. An understanding of the theory of operation (section III) and frequent reference to the schematic diagram will be of great value in troubleshooting.

SYMPTOM	PROBABLE CAUSE	REMEDY
<p>Drift of the 500 volt DC reference supply evidenced by the continual need for resetting with the CALBRATE control.</p>	<p>V102, V104, or V105 defective.</p> <p>One of the sampling string resistors (R123, R124, R121) is changing value rapidly as the instrument warms up.</p> <p>Drifting standard cell emf possibly caused by previous shorting or inverting of the cell. (803D and 803DR)</p>	<p>Check V102, V104, and V105 by replacement.</p> <p>Locate faulty resistor by heating slightly with a soldering iron held near the resistor while observing the 500 volt DC calibration.</p> <p>Allow time for the standard cell to stabilize. Several hours should be sufficient.</p>
<p>Cannot calibrate 500 volt DC reference supply.</p> <p>Meter cannot be brought to zero with CALIBRATE control.</p>	<p>Excessive aging of V102.</p> <p>Out of calibration.</p> <p>One or more resistors in 500 volt DC sampling string has shifted in value.</p> <p>Standard cell emf has shifted. (803D and 803DR)</p>	<p>Check V102 by replacement.</p> <p>Recalibrate per paragraph 4-4b.</p> <p>Recalibrate per paragraph 4-4b and observe stability for 48 hours. If 500 volt DC reference supply remains stable, replacement of resistor is unnecessary.</p> <p>Recalibrate instrument and observe stability of reference supply. Replacement of the standard cell may be necessary.</p>
<p>Measurements are out of tolerance on one range other than the 500 volt range.</p>	<p>A reference supply output range resistor on the range resistor printed circuit board is out of tolerance.</p>	<p>If the trouble occurs in the 50 volt range, R324 has shifted; in the 5 volt range, R325 or R327 has shifted, in the 0.5 volt range, R328 or R330 has shifted. It may be possible to correct by recalibration. If not, replace faulty resistor.</p>
<p>Measurements are out of tolerances on all ranges other than the 500 volt range.</p>	<p>R320 or R321 has shifted in value.</p>	<p>It may be possible to correct all range voltages by recalibration. If not, replace faulty resistor.</p>
<p>Measurements are out of tolerance on any range when the Kelvin-Varley divider is dialed to any setting other than 499910.</p>	<p>One of the Kelvin-Varley divider resistors is out of tolerance.</p>	<p>Measure the voltage drop across each Kelvin-Varley resistor with another John Fluke Differential Voltmeter. Begin by setting RANGE switch to 500 volts and the voltage readout dials to 499.910. Reference to the schematic diagram will show that there should be 100, 10, 1, 0.1, and 0.01 volts respectively across each resistor of the A, B, C, D, and E decades, except for the two resistors of each decade that are paralleled by the following decade. Across these two resistors, there should be 50, 5, 0.5, and 0.05 volts, respectively. Voltage measurements should be within 0.01% of each other. Remember that if one resistor in a decade has increased or decreased appreciably, the voltage drop across all other resistors in the decade will be slightly affected also.</p>
<p>Instrument is out of specifications on all range.</p>	<p>Resistors R306, R307, R308, R309, or R310 out of tolerance.</p>	<p>Check and replace faulty resistor.</p>

Figure 4-1. TROUBLESHOOTING (sheet 1 of 2)

SYMPTOM	PROBABLE CAUSE	REMEDY
Meter rattle, drift, or error is observed on all null ranges.	V202, V203, or V204 faulty. Chopper G1 faulty. Moisture or dirt on printed circuit boards or switches.	Check V202, V203, and V204 by replacement. Replace chopper. Clean instrument.
<b>NOTE: Assuming all DC measurements are normal, the following symptoms are common to AC measurements only.</b>		
Measurements are out of tolerance on 500 volt AC range only.	Out of calibration. One or more resistors in 500 volt AC attenuator has shifted in value.	Recalibrate per paragraph 4-4c. Recalibrate per paragraph 4-4c. Recheck calibration after 48 hours and if attenuator has remained stable, replacement of resistor is unnecessary. If attenuator does not remain stable, or calibration is not possible, replace faulty resistor.
Measurements are out of tolerance on 50 volt AC range only.	Out of calibration. One or more resistors in 50 volt AC attenuator has shifted in value.	Recalibrate per paragraph 4-4c. Recalibrate per paragraph 4-4c. Recheck after 48 hours and if attenuator has remained stable, replacement of resistor is unnecessary. If attenuator does not remain stable or if calibration is not possible, replace faulty resistor.
Measurements out of tolerance on all AC ranges.	Out of calibration. V501 or V502 faulty.	Recalibrate per paragraph 4-4c. Check V501 and V502 by replacement.
Measurements out of tolerance at a specific frequency.	Out of calibration. Faulty frequency compensation capacitor.	Recalibrate per paragraph 4-4c. Locate faulty capacitor and replace. If trouble occurs on all ranges, check C504. If trouble occurs on 500 volt range only, check C501, C502, and C521. If trouble occurs on 50 volt range only, check C523 and C524. If trouble occurs on 500, 50, and 5 volt range, check C520. If trouble occurs on 0.5 volt range check C519.

Figure 4-1. TROUBLESHOOTING (sheet 2 of 2)

b. TUBE REPLACEMENT. Many differential amplifier circuits are critical with respect to the balance between halves of differential amplifier tubes. This is especially true of the first stage of amplification. However, the 803D is designed with the ability to use any 12AX7 for V104 and V105 that meets standard EIA (Electronics Industries Association) characteristics. Some output voltage drift of the 500 volt reference supply may be noted for the first few hours of operation. This drift will, in most cases, decrease to a small value after the tube has aged a bit. Occasionally a tube with a contaminated grid or extremely poor balance between halves will be found. This tube should be discarded. When replacing reference tube V102, the new tube should be aged at least 150 hours to realize the high order of stability inherent in the 803D. A tube that has been aged may be obtained by ordering an 0G3-2 from Fluke.

c. Replacement of tubes will not normally necessitate complete recalibration of the 803D. If V202 or V203 is replaced, calibrate the null detector as set forth in paragraphs 4-4b (1) and 4-4b (2). Replacement of V101, V102, V104, or V105 will necessitate calibration of the reference supply per paragraphs 4-4b (1) and 4-4b (3). If V501 or V502 is replaced, calibrate the AC to DC converter as in paragraph 4-4c.

d. COMPONENT REPLACEMENT. Should it ever become necessary to replace a component on a printed circuit board or on the null detector chassis, proceed as follows :

- (1) Clean soldered area around component with methyl ethyl ketone.
- (2) Remove part and install new component.
- (3) Remove flux with du Pont Freon PC.

(4) Allow to dry for 10 minutes. When it is cool or humid, it may be necessary to place area under a lamp to ensure thorough drying.

(5) Coat any uncoated areas around R301 through R310 on the range resistor board and around the input to the null detector chassis (tube V202, 5751, and chopper) with Humi-Seal 1B12 (manufactured by Columbia Technical Corp. of Woodside, N.Y.).

e. STANDARD CELL PROBLEMS. The standard cell of the 803D and 803DR deserves special consideration if it is suspected of being faulty:

(1) The standard cell used is a miniature unsaturated cell which has excellent long term stability and negligible temperature-voltage hysteresis. (Temperature-voltage hysteresis is the erratic behavior of the voltage while the cell is coming to equilibrium following a change in temperature.) Under normal conditions this cell should last from 8 to 15 years. In rare instances, failure has occurred in less than 2 years. End of life is usually marked by an increase in temperature voltage hysteresis affect. That is, reading errors in excess of 0.01% will result when the same voltage is read with the 803D hot and cold. The emf of different cells may vary as much as 0.05% and each instrument is calibrated to its own particular standard cell. Thus, when the standard cell is replaced, the 803D reference supply must be

recalibrated as in paragraph 4-4c.

(2) Failure of the standard cell may occur if subjected to below freezing temperature. The electrolyte will start to freeze at about 5°F and operation below 32°F is definitely not recommended. The life of the cell will also be greater if the 803D is not operated at elevated temperature. The 8 to 15 year figure holds for operation of the instrument at normal room temperature, 72(+3)°F.

(3) The emf of the standard cell will change if the cell has been inverted, or if the cell has been inadvertently short-circuited. If the emf has changed, the 803D will naturally be out of calibration on all ranges. In either case, the cell will return to its original emf. If the cell were inverted or shorted for only a few seconds, the 803D should be able to measure voltages within specifications after several hours recovery time.

f. DECIMAL LAMP REPLACEMENT. The decimal lamps are normal 6.3 volt lamps. To prolong their life these lamps are operated from a 5 volt transformer winding. However, these lamps do occasionally fail. To replace, proceed as follows:

(1) On cabinet models, remove screws at back of cabinet and slide instrument out of case. If only the upper most decimal lamp needs to be replaced, proceed to step (6).

(2) Remove four screws that hold front panel assembly to chassis.

Symbol & Type	Pin 1	Pin 2	Pin 3	Pin 4	Pin 5	Pin 6	Pin 7	Pin 8	Pin 9
V101, 6BQ5	No Conn.	495	500	Heater voltage 6.3 volts ac		No Conn.	680 to 730	No Conn.	680 to 730
V102, OG3	85	0	Int. Conn.	0	85	Int. Conn.	0	No Pin	No Pin
V104, 12AX7	217	84	36	Heater voltage 5.9 volts dc		217	84	86	See Pin 4 & 5
V105, 12AX7	495	217	220	Heater voltage 6.3 volts ac		500	217	220	
V202, 5751	60	-	0	Heater voltage 12 volts dc		100	-	1.5	No Conn.
V203, 6AW8	47	45	140	Heater voltage 6.3 volts ac		0.7	-	25	50
V204, OA2	150	0	Int. Conn.	0	150	Int. Conn.	0	No Pin	No Pin
V501, 6EJ7	1.3	-	1.3	Heater voltage 5.9 volts dc		0	150	93	1.3
V502, 6AW8	28	-	200			1.8	-	100	150 (±50%)

This chart is to be used under the following conditions: (a) RANGE switch set to 500; (b) NULL switch set to VTVM; (c) all voltage readout dials set to zero; (d) polarity switch set to +; (e) line voltage at 115/230 volts, 50 - 60 cycles; (f) all measurements made with vtvm from negative binding post to specified terminal; and (g) all voltages may vary by 20% unless otherwise indicated.

Figure 4-2. TUBE VOLTAGE CHART

(3) Being careful to avoid wiring damage, gently lift front panel assembly from instrument and set face down in front of instrument.

(4) Remove screws holding range resistor board to front panel assembly.

(5) Push printed circuit board aside enough to allow access to light holders.

(6) Remove light holder from bracket by applying pressure to each side of holder.

(7) Remove cardboard light shield and replace lamp.

(8) On rack models, remove screws holding cover to instrument and set cover aside.

(9) Remove light holder from bracket by applying pressure to each side of holder.

(10) Remove cardboard light shield and replace lamp.

#### 4-4. CALIBRATION

a. GENERAL. The calibration procedure is divided into two main parts: DC differential voltmeter calibration (paragraph 4-4b) and AC to DC converter calibration (paragraph 4-4c). The 803D may be calibrated as often as deemed necessary. However, it is recommended that DC differential voltmeter calibration be done every 3 months. The AC to DC converter calibration should be done every month. For special applications where extreme accuracy is required, it may be desired to calibrate the instrument more often. Calibration should be accomplished in a draft-free area with an ambient temperature of 72(±3)°F for maximum accuracy under laboratory conditions. The recommended equipment and the specifications required for calibration are shown in figure 4-3. All controls on the cabinet model may be located with the aid of figure 4-4. The instrument must be calibrated in its cabinet. The ventilation holes on the cabinet model provide an easy means of reaching R121, R222, and R232. An insulated screwdriver must be used when adjusting these controls to prevent shorting the control to chassis ground. To reach the calibration controls at the front of cabinet models, the instrument must be slid partly out of its cabinet. On rack models, all controls may be easily reached through labeled access holes.

b. DC DIFFERENTIAL VOLTMETER CALIBRATION. For convenience, the DC differential voltmeter calibration is divided into four parts: preliminary calibration, null detector calibration, reference supply calibration, and range divider calibration. Normally, all four parts are performed in the sequence given here. However, the calibration procedure is written so that any part may be calibrated by performing the procedure for just that part.

##### (1) Preliminary Calibration Procedure.

(a) Set 803D meter to zero with mechanical adjustment screw on front of meter case.

(b) Set switches on 803D as follows:

RANGE	500
NULL	VTVM
AC - DC polarity	+ (positive)
all voltage read-out dials	0 (zero)

(c) Set power switch to ON and allow 803D to warm to equilibrium temperature (about 1 hour) inside its case. Meanwhile, proceed with step (d).

RECOMMENDED EQUIPMENT	SPECIFICATIONS REQUIRED
<p>DC CALIBRATION:</p> <p>Fluke 301C or 301E Power Supply</p> <p>Saturated standard cell bank with an accuracy of ±0.001%</p> <p>Voltage reference divider having division ratios of 1, 10, 100, and 1000 with an accuracy of ±0.001%</p> <p>Galvanometer suitable for use with above voltage reference divider</p>	<p>The equipment used must provide 500, 50, 5, and 0.5 volts with an accuracy of 0.005%.</p>
<p>AC CALIBRATION:</p> <p>Fluke Model 821A Differential Voltmeter</p> <p>Fluke 301C or 301E Power Supply</p> <p>Krohn-Hite LDS-1500 oscillator</p> <p>Fluke 540A Transfer Standard</p>	<p>The equipment used must provide 500, 50, 5, and 0.5 volts AC at 400 cycles, 10 kilocycles, and 20 kilocycles with an accuracy of at least 0.03% and with less than 0.1% total harmonic distortion.</p>

Figure 4-3. CALIBRATION EQUIPMENT

(d) Set up necessary equipment to provide DC voltages of 500, 50, 5, and 0.5 volts DC with an accuracy of 0.005%. Proceed as follows: turn on all test equipment and allow it to warm to equilibrium temperature (about 1/2 hour); set proper standard cell voltage on divider; apply 500 volts DC into divider from power supply; set divider to 500 and zero galvanometer by varying output of power supply; voltages of 500, 50, 5, and 0.5 volts DC are made available at output posts by merely changing position of voltage selector switch on voltage divider.

(e) Connect chassis ground binding post to line ground.

##### (2) Null Detector Calibration.

(a) Perform preliminary calibration procedure as stated in paragraph 4-4b (1).

(b) Adjust null detector ZERO ADJ control R232 until meter indicates zero.

(c) Apply 500 volts DC (±0.005%) to voltmeter.

(d) Adjust VTVM GAIN ADJ control R222 for full scale deflection.

(3) 500 VDC Reference Supply Calibration.  
(a) Perform preliminary calibration procedure as stated in paragraph 4-4b (1).  
(b) Center CALIBRATE control at its center of rotation.

(c) Set NULL switch to 10 and voltage readout dials to 499.910.

(d) Apply 500 volts DC ( $\pm 0.005\%$ ) to voltmeter.

(e) Adjust 500V ADJ control R121 for a null.

(f) Set NULL switch to 0.1 volt.

(g) Null meter by adjusting CALIBRATE control.

(h) Advance OPERATE-CALIBRATE switch against spring tension to CALIBRATE and null meter by adjusting REF CAL ADJ control R318.

(4) Range Divider Calibration.

(a) Perform preliminary calibration procedure as stated in paragraph 4-4b (1).

(b) Set switches on 803D as follows:

RANGE	50
NULL	0.01
voltage read-out dials	49.99 <u>10</u>

(c) Apply 50 volts DC ( $\pm 0.005\%$ ) to voltmeter.

(d) Null 803D meter by adjusting 50V DC ADJ control R323.

(e) Set RANGE switch to 5 volts.

(f) Apply 5 volts DC ( $\pm 0.005\%$ ) to voltmeter.

(g) Null 803D meter by adjusting 5V DC ADJ control R326.

(h) Set RANGE switch to 0.5 volts.

(i) Apply 0.5 volts DC ( $\pm 0.005\%$ ) to voltmeter.

(j) Null 803D meter by adjusting 0.5V DC ADJ control R329.

This completes the DC differential voltmeter calibration.

c. AC TO DC CONVERTER CALIBRATION. The DC Differential Voltmeter section of the 803D must be within specifications before the AC to DC Converter can be accurately calibrated. The AC to DC Converter must be calibrated in the following order.

(1) Preliminary Calibration Procedure.

(a) Zero instrument as stated in paragraph 2-2.

(b) Set switches on 803D as follows:

RANGE	500
NULL	0.01
AC - DC polarity	AC
voltage readout dials	499.9 <u>10</u>

(c) Check for excessive converter output noise as follows: set RANGE switch to 0.5, NULL switch to 0.01, AC - DC polarity switch to AC, and all voltage readout dials to 0 (zero); short input terminals of 803D; if the meter needle is not within 150 microvolts (7-1/2 small divisions) of null, converter noise is excessive and the trouble must be corrected before proceeding with calibration; if trouble occurs it is usually the result of the input tube (V501), the filament supply, or the 500 volt supply being noisy; remove short from input terminals.

(d) Allow 803D to warm to equilibrium temperature inside its case (about 1 hour). Meanwhile, proceed with step (e).

(e) Set up the necessary equipment to provide 500, 50, 5, and 0.5 volts AC with an accuracy of at least  $\pm 0.03\%$  at frequencies of 400 cycles, 10 kilocycles, and 20 kilocycles with less than 0.1 total harmonic distortion. Proceed as follows: connect equipment as shown in figure 4-5; turn on all test equipment and allow it to warmup to equilibrium temperature (about 1/2 hour; adjust DC power supply voltage until differential voltmeter indicates rms value of AC voltage

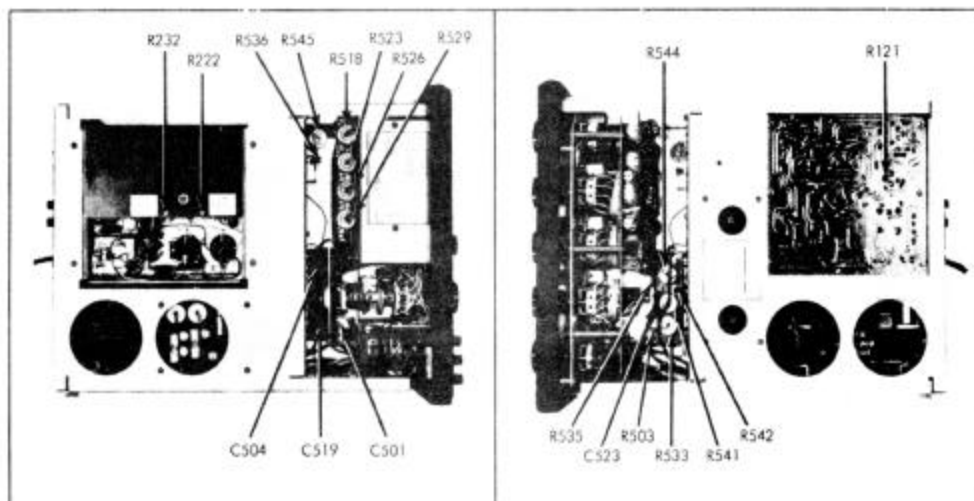

Figure 4-4. ADJUSTMENT LOCATIONS

required; apply output DC supply to 540A and null galvanometer by adjusting internal reference supply voltage; apply output of AC oscillator to 540A and null galvanometer by adjusting AC oscillator voltage; the output of the oscillator now equals the required voltage.

(2) 0.5 VAC Converter Gain Adjustment.

- (a) Set RANGE switch to 0.5 volt position.
- (b) Apply 0.5 volt AC at 400 cycles to volt

meter.

(c) Adjust 0.5 VAC GAIN COARSE ADJ control R536 and 0.5 VAC GAIN FINE ADJ control R545 until meter needle is within  $\pm 30$  microvolts (1-1/2 small divisions) of null. Use R545 for final touch up trying to keep control in center third of its mechanical range. Note position of meter needle.

(3) 5 VAC Converter Gain Adjustment

- (a) Set RANGE switch to 5 volt position.
- (b) Apply 5 volts AC a 400 cycles to

voltmeter.

(c) Adjust 5 VAC GAIN COARSE ADJ control R542 and 5 VAC GAIN FINE ADJ control R541 until meter needle is within  $\pm 30$  microvolts (1-1/2 small divisions) of null. Use R541 for final touch up trying to keep control in center third of its mechanical range. Note position of meter needle.

(4) 5 VAC High Frequency Adjustment

- (a) Apply 5 volts AC at 10 kilocycles to

voltmeter.

(b) Adjust 5 VAC HF TRIM control C504 until meter needle is within  $\pm 30$  microvolts (1-1/2 small divisions) of needle position noted in (3).

(5) 0.5 VAC High Frequency Adjustment.

- (a) Set RANGE switch to 0.5 volt position.

(b) Apply 0.5 volt AC at 20 kilocycles to voltmeter.

(c) Adjust 0.5 VAC HF TRIM control C519 until meter needle is within  $\pm 30$  microvolts (1-1/2 small divisions) of needle position noted in (2).

(6) 0.5 VAC Converter Gain Check.

(a) Apply 0.5 volt AC at 400 cycles to voltmeter.

(b) If meter needle is not within  $\pm 50$  microvolts (2-1/2 small divisions) of null, adjust 0.5 VAC GAIN FINE ADJ control R545 and then repeat (3), (4), and (5) before continuing with (7).

(7) 5 VAC Converter Gain Check.

- (a) Set RANGE switch to 5 volt position.

(b) Apply 5 volts AC at 400 cycles to voltmeter.

(c) If meter needle is not within  $\pm 50$  microvolts (2-1/2 small divisions) of null, adjust 5 VAC GAIN FINE ADJ control R541 and repeat (4) and (5) before continuing with (8).

(8) 500 VAC Attenuator Adjustment.

- (a) Set RANGE switch to 500 volt position.

(b) Apply 500 volts AC at 400 cycles to voltmeter.

(c) Adjust 500 VAC ATTEN COARSE ADJ control R535 and 500 VAC ATTEN FINE ADJ control R544 until meter needle is within  $\pm 30$  microvolts (1-1/2 small divisions) of null. Use R544 for final touch up trying to keep control in center third of its mechanical range. Note position of meter needle.

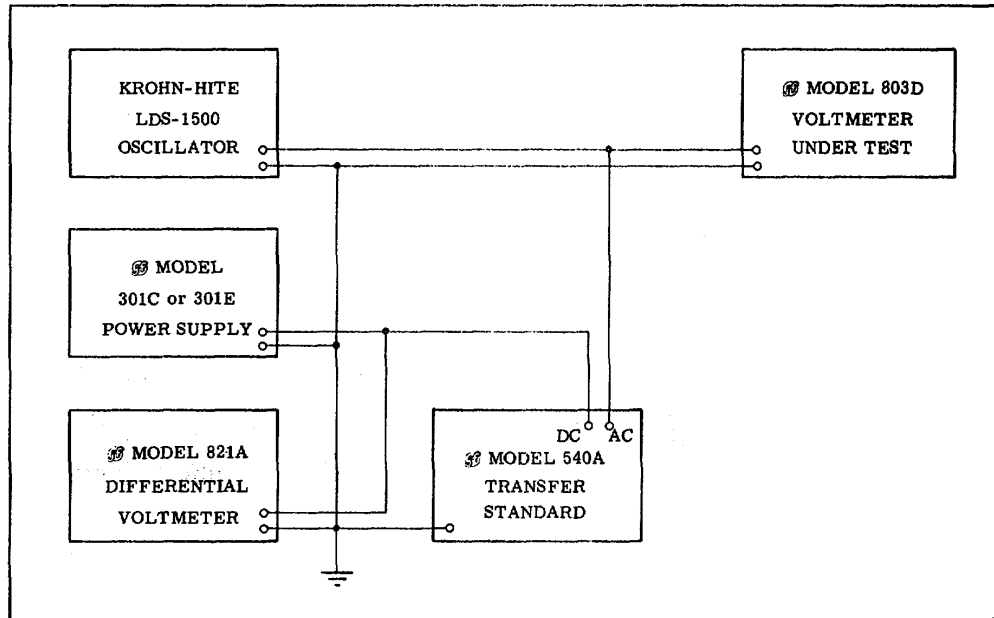

Figure 4-5. AC TO DC CONVERTER CALIBRATION SET-UP

- (9) 500 VAC High Frequency Adjustment.  
(a) Apply 500 volts AC at 10 kilocycles to voltmeter.  
(b) Adjust 500 VAC HF TRIM control C501 until meter needle is within  $\pm 30$  microvolts (1-1/2 small divisions) of needle position noted in (8).
- (10) 500 VAC Attenuator Check.  
(a) Apply 500 volts AC at 400 cycles to voltmeter.  
(b) If meter needle is not within  $\pm 50$  microvolts (2-1/2 small divisions) of null, adjust 500 VAC ATTEN FINE ADJ control R544 and repeat (9) before continuing with (11).
- (11) 50 VAC Attenuator Adjustment.  
(a) Set RANGE switch to 50 volt position.  
(b) Apply 50 volts AC at 400 cycles to voltmeter.  
(c) Adjust 50 VAC ATTEN COARSE ADJ control R50 and 50 VAC ATTEN FINE ADJ control R533 until

meter needle is within 30 microvolts (1-1/2 small divisions) of null. Use R533 for final touch up trying to keep control in center third of its mechanical range.

Note position of meter needle.

- (12) 50 VAC High Frequency Adjustment.  
(a) Apply 50 volts AC at 10 kilocycles to voltmeter.  
(b) Adjust 50 VAC HF TRIM control C523 until meter needle is within  $\pm 30$  microvolts (1-1/2 small divisions) of needle position noted in (11).
- (13) 50 VAC Attenuator Check.  
(a) Apply 50 volts AC at 400 cycles to voltmeter.  
(b) If meter needle is not within  $\pm 50$  microvolts (2-1/2 small divisions) of null, adjust 50 VAC ATTEN FINE ADJ control R533 and repeat (12). This completes AC to DC converter calibration.



SECTION V

LIST OF REPLACEABLE PARTS

5-1. GENERAL

a. The following eight assembly lists describe all normally replaceable parts of the Model 803D, 803DR, 803D/AG, and 803DR/AG Differential AC/DC Voltmeters. Each list has a corresponding illustration on which the parts for that list are pointed out. Parts are called out on both lists and illustrations by reference designations from the schematic diagram. Those parts (mechanical which have no reference designation are shown on the illustrations by Fluke Stock Number.

b. A Use Code column is provided to identify certain parts that have been added, deleted, or modified during production of the 803D. Each part for which a use code has been assigned may be identified with a particular instrument serial number by consulting the Use Code Effectivity List at the end of this section.

5-2. HOW TO OBTAIN PARTS

a. Standard components have been used whenever possible. Thus, most parts may be obtained locally. However, special components are used in some instances. All parts manufactured or altered by Fluke and all parts for which Fluke controls the design are designated by an asterisk preceding the Fluke stock number. All structural parts and special parts should be purchased from your local Fluke representative or from the factory.

b. When ordering parts always include:

- (1) Reference designation, description, and Fluke stock number.
- (2) Instrument model and serial number.
- (3) Most structural parts are not listed. In this case, give complete description, function, and location for the part.

REFERENCE DESIGNATION	DESCRIPTION	FLUKE STOCK NO.	USE CODE
	Final Assembly (Cabinet model, standard cell option) (Rack model, standard cell option) (Cabinet model, Zener diode option)	*803D-509 *803DR-509 *803D/AG-509	
	Front Panel Assembly (See figure 5-2)	*803D-435 *803DR-508 *803D/AG-435	
	Reference Supply Board Assembly (See figure 5-3)	*803D-449	
	Null Detector Chassis Assembly (See figure 5-4)	*803C-451	
	Range Resistor Board Assembly (See figure 5-5)	*803D-404 *803DR-430 *803D/AG-404	
	Kelvin-Varley Resistor Board Assembly (See figure 5-6)	*801B-403	
	Converter/AC Range Switch Assembly (See figure 5-7)	*803D-438	
	Chopper Drive Board Assembly (See figure 5-8)	*803C-450	

REFERENCE DESIGNATION	DESCRIPTION	FLUKE STOCK NO.	USE CODE
F1	Fuse, 1.5 ampere, slow blowing (for 115 volt operation) Fuse, 0.75 ampere, slow blowing (for 230 volt operation) Fuse holder	F1, 5A  F-3/4A X12	
J4, J5	Binding post, red Binding post insulator, dual, black	X2231 *801B-830	
Q3	Transistor, germanium, PNP, special purpose 2N301W	*SC14	
R1	Resistor, variable wirewound, 10K $\pm$ 10%, 2W	P10KA	
R3	Resistor, precision power (803D/AG and 803DR/AG. Optimum value is selected at factory to match Zener diode. When ordering, include date and serial number listed on Range Resistor Printed Circuit Board decal.)		
R6, R7	Resistor, wirewound, 6K $\pm$ 5%, 5W	R6KW	
T1	Transformer, power  Line cord, 3 wire  Rubber foot  Case Assembly (Cabinet model)  Handle, flexible black vinyl, 5-1/2" (Cabinet model)	*803C-651  X27H  X224  *803B-271  407-101	

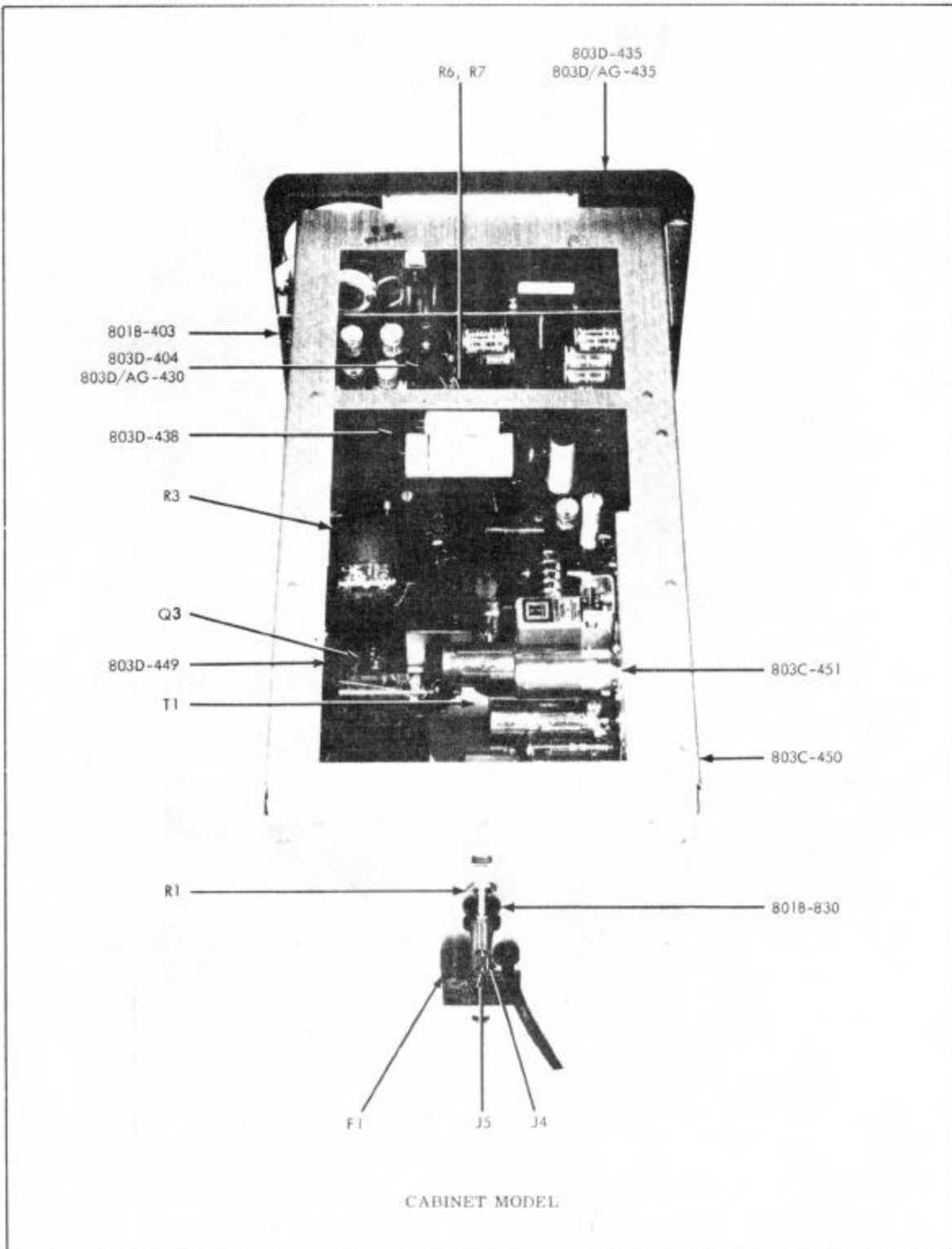

Figure 5-1. FINAL ASSEMBLY (sheet 1 of 2)

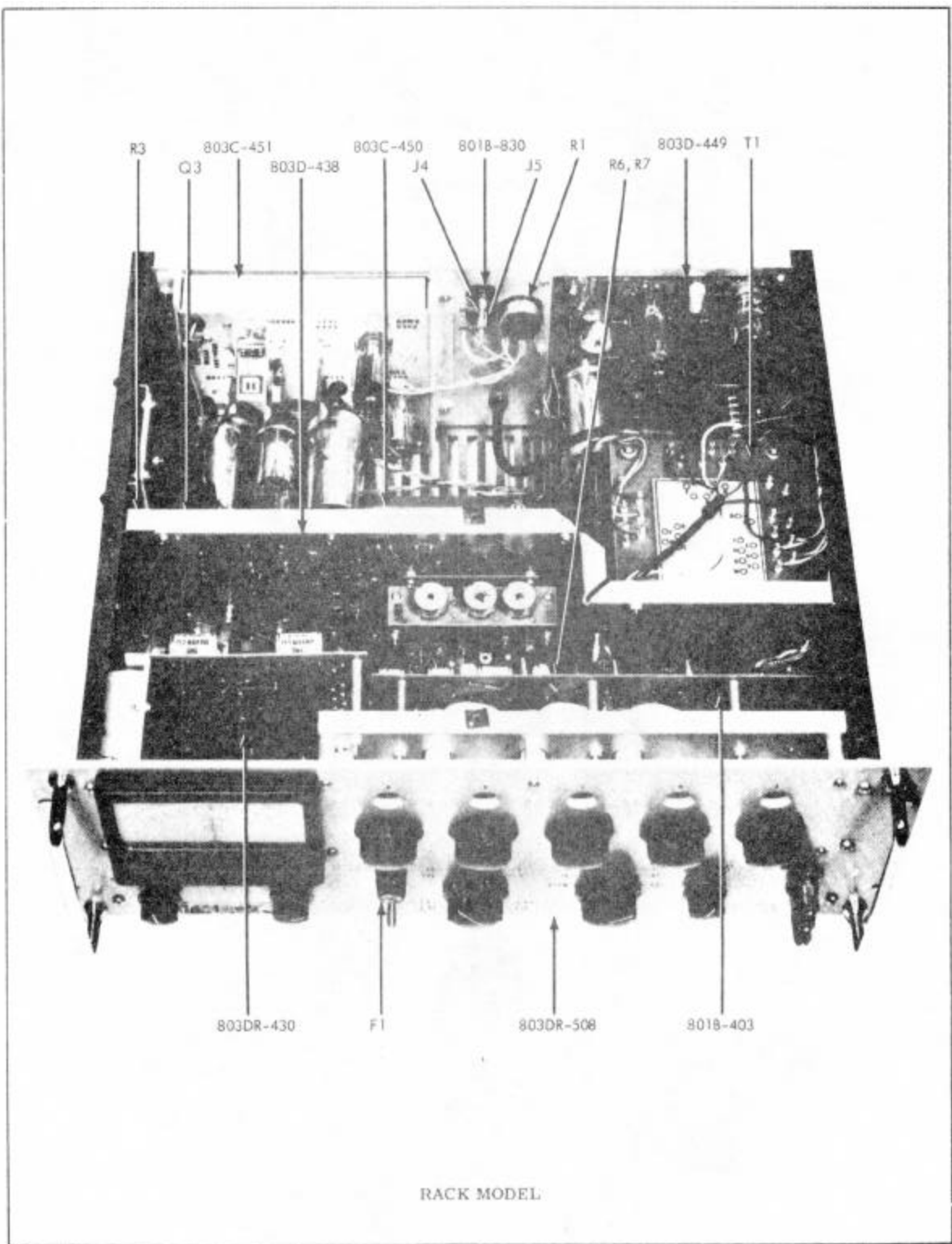

Figure 5-1. FINAL ASSEMBLY (sheet 2 of 2)

REFERENCE DESIGNATION	DESCRIPTION	FLUKE STOCK NO.	USE CODE
	Front Panel Assembly	*803D-435 *803 DR-508 *803D/AG-435	
B1	Standard cell	X223	
C1	Capacitor, plastic, 0.47 uf $\pm$ 10%, 600V	CP25	
DS1, DS2, DS3, DS4	Lamp, decimal Light holder Light shield Light lens	X2051 X16 X264 X2096	
J1, J2	Binding post, red Binding post, insulator, dual, black Binding post, insulator, black (Cabinet model) Shorting link	X2231 *801B-830 *801B-831 X221	
J3	Binding post, black Binding post, spacer	X219 X220	
M1	Meter, 100-0-100 microamp	*M56	
R2	Resistor, variable wirewound, dual section, 1K and 100 $\Omega$ $\pm$ 10%, 2W	P1KD	
S1	Switch, power	ST5	
S2	Switch, range, DC section	*803D-812	
S3	Switch, null	*825A-812	
S4	Switch, operate-calibrate	*801B-828	
S5	Switch, AC - DC polarity	*823A-805	
S6	Switch, voltage dial A	*801B-819	
S7, S8, S9	Switch, voltage dials B, C, and D	*801B-820	
S10	Switch, voltage dial E Knob, 1 inch with pointer Knob, 1-1/2 inch without pointer Knob, 1-1/2 inch with pointer Knob, 1-1/2 inch with index line Voltage dial plates (Cabinet model) (Rack model) Handle, 6" chrome plated (rack model)	*801B-821 X231 X207 X234 X2085 D3 D2 X340	

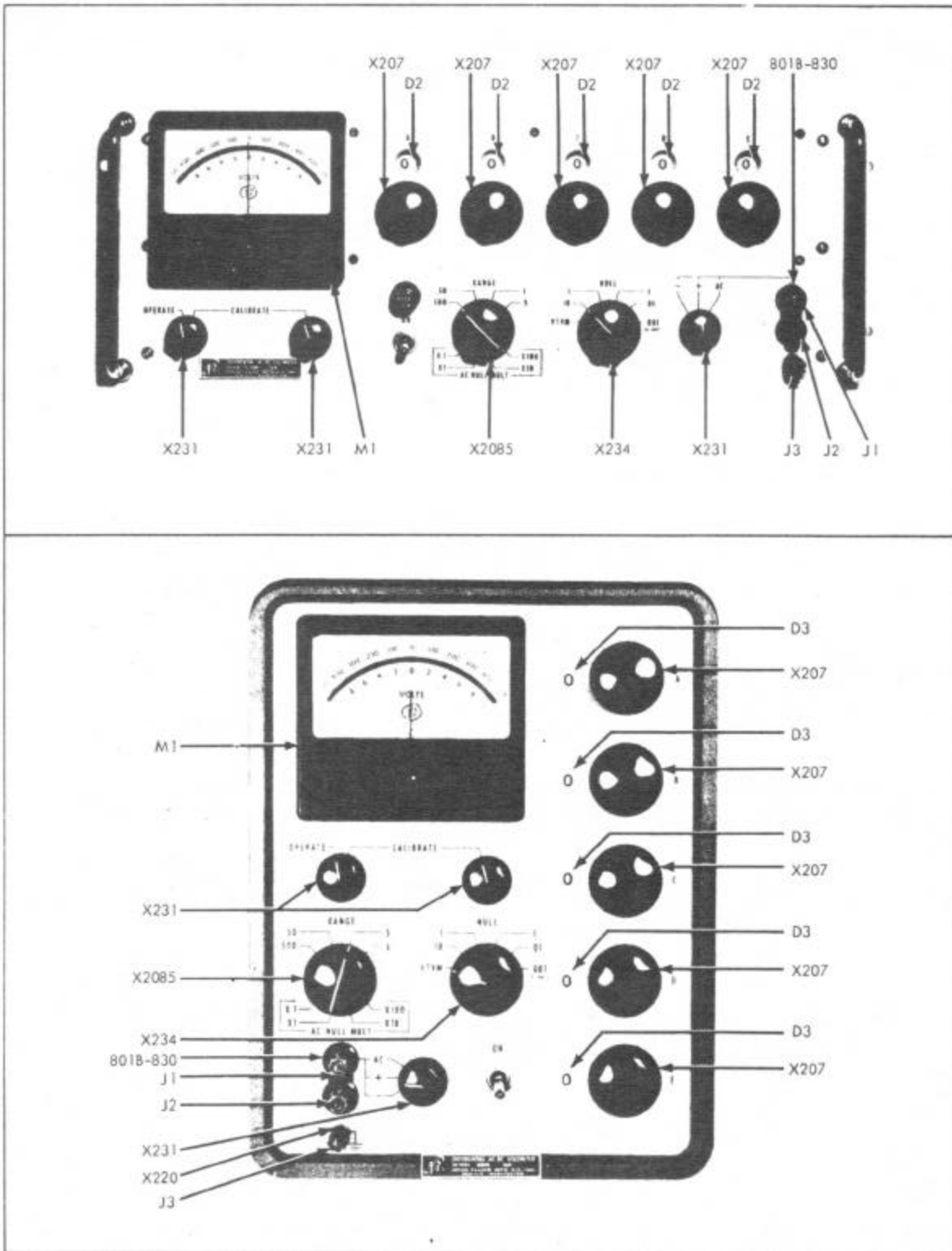

Figure 5-2. FRONT PANEL ASSEMBLY (sheet 1 of 2)

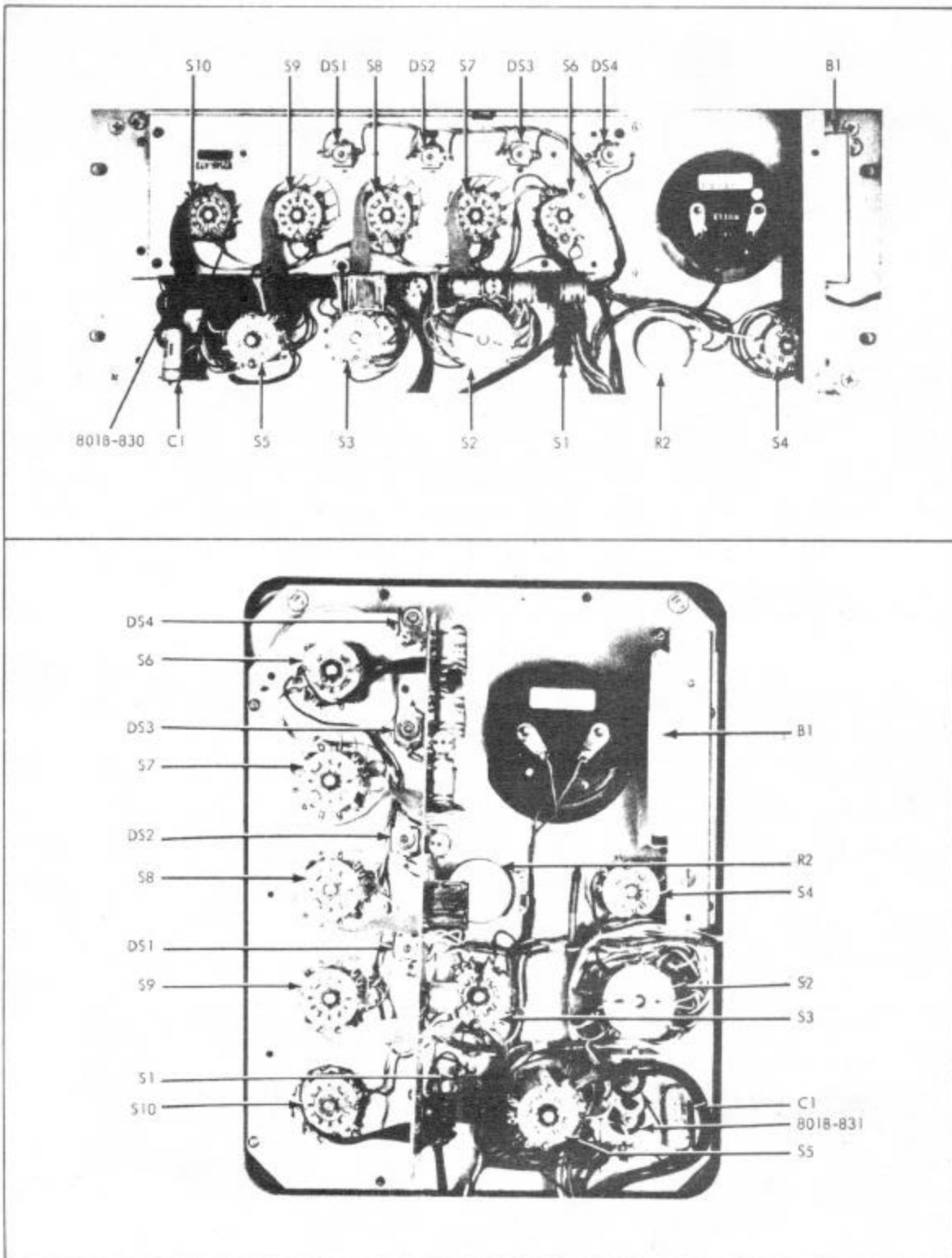

Figure 5-2. FRONT PANEL ASSEMBLY (sheet 2 of 2)

REFERENCE DESIGNATION	DESCRIPTION	FLUKE STOCK NO.	USE CODE
	Reference Supply Board Assembly without tubes	*803D-449	
C101, C102	Capacitor, electrolytic, 20 uf -10/+100%, 500V	CE52	
C103	Capacitor, electrolytic, 4000 uf -10/+100%, 15V	CE23	
C104	Capacitor, paper, 0.1 uf ±20%, 400V	CP4	
C105	Capacitor, plastic, 0.033 uf ±20%, 600V	CF19	
C106	Capacitor, plastic, 0.1 uf ±20, 600V	CF20	
C107	Capacitor, ceramic, 0.01 uf -20/+80%, 500V	CT18	
CR101 thru CR103	Diode, silicon, 0.750 Amp, 600 PIV	RE18	
CR104, CR105	Diode, silicon, 1 Amp, 50 PIV	RE8	
Q1	Transistor, germanium, NPN, 2N214	2N214	A
	Transistor, silicon, NPN, 2N2712	*SC21	B
Q2	Transistor, germanium, PNP, 2N1372	2N1372	
R101	Resistor, composition, 1 Meg ±10%, 1/2W	EB1051	
R102	Resistor, composition, 220K ±10%, 1/2W	EB2241	
R104	Resistor, carbon film 5K ±1%, 1/2W	DR49	A
	Resistor, carbon film, 5.44K ±1%, 1/2W	DR410	B
R105	Resistor, carbon film, 135K ±1%, 1/2W	DR65	A
	Resistor, carbon film, 125K ±1%, 1/2W	DR629	B
R106	Resistor, composition, 8.2K 10%, 1/2W	EB8221	
R107, R108	Resistor, carbon film, 50Ω ±1%, 1/2W	DR22	
R109, R110	Resistor, composition, 270K ±10%, 1W	GB2741	
R111	Resistor, composition, 22 Meg ±10%, 1/2W	EB2261	
R112	Resistor, composition, 15 Meg ±10%, 1/2W	EB1561	
R113	Resistor, composition, 10 Meg ±10%, 1/2W	EB1061	
R114	Resistor, composition, 100K ±10%, 1W	GB1041	
R115	Resistor, wirewound, 140K ±3%, 10W	R140KW	
R116	Resistor, composition, 100K ±10%, 1/2W	EB1041	
R117	Resistor, composition, 560K ±10%, 1W	GB5641	
R118	Resistor, composition, 220K ±10%, 1/2W	EB2241	
R119	Resistor, composition, 330Ω ±10%, 1/2W	EB3311	
R120	Resistor, composition, 220K ±10%, 1W	GB2241	
R121	Resistor, variable wirewound, 5K ±20%, 1-1/4W	P5KM	
R122	Resistor, composition, 560K ±10%, 1W	GB5641	
R123	Resistor, wirewound, 386K ±0.5%, 1W	PR641	
R124	Resistor, wirewound, 76K ±0.5%, 1/2W	PR59	



REFERENCE DESIGNATION	DESCRIPTION	FLUKE STOCK NO.	USE CODE
R125	Resistor, composition, 82K $\pm$ 10%, 1/2W	EB8231	
V101	Vacuum tube, pentode, EL84/6BQ5	EL84/6BQ5	
V102	Vacuum tube, voltage reference, OG3	OG3-2	
V103	Lamp, neon glow, NE2E	X40B	
V104, V105	Vacuum tube, duo triode, 12AX7	12AX7	

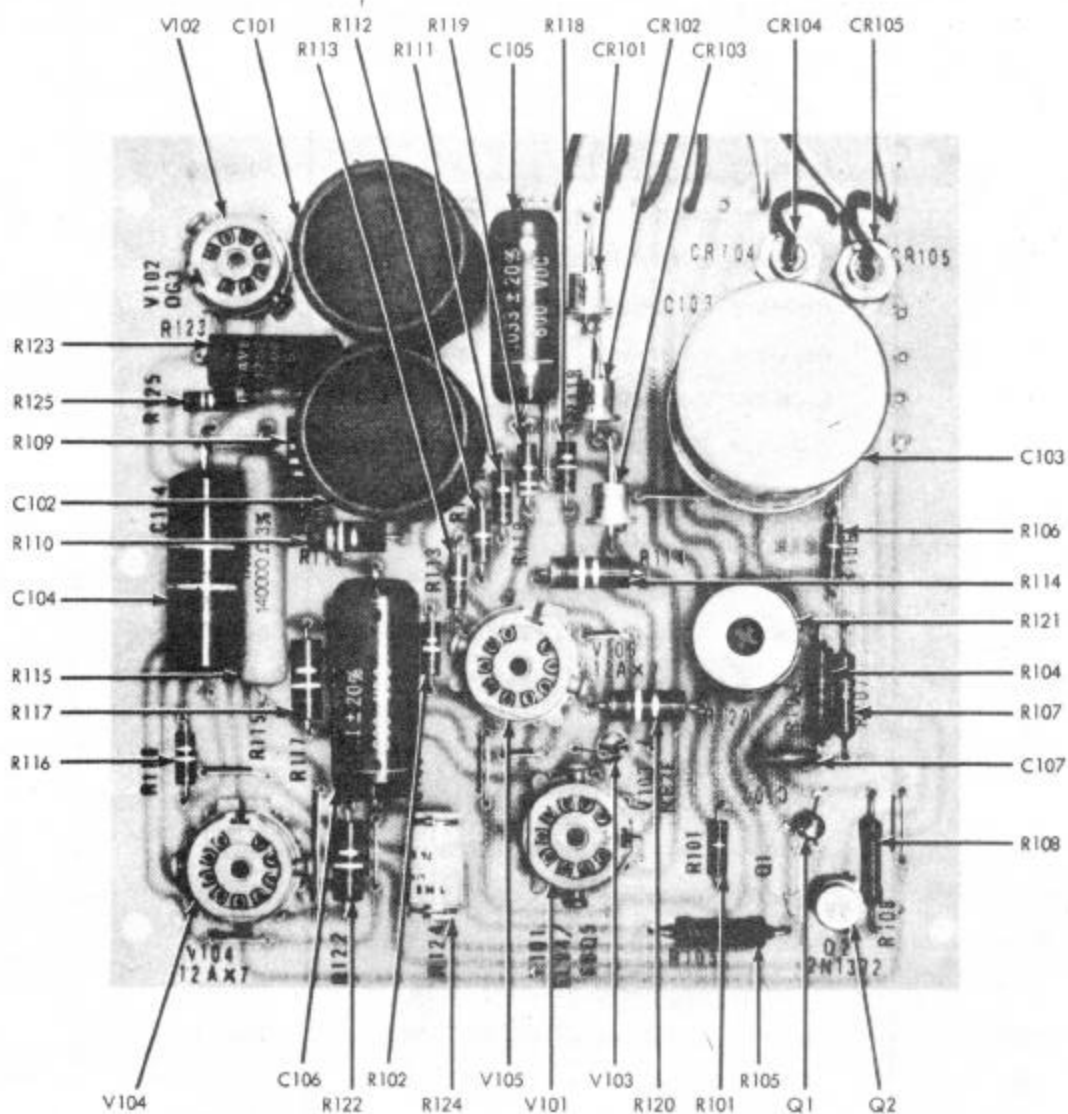

Figure 5-3. REFERENCE SUPPLY BOARD ASSEMBLY

REFERENCE DESIGNATION	DESCRIPTION	FLUKE STOCK NO.	USE CODE
	Null Detector Chassis Assembly without tubes	*803C-451	
C201, C202	Capacitor, plastic, 0.1 uf $\pm 20\%$ , 100V	CF49	
C203	Capacitor, paper, 0.047 uf $\pm 20\%$ , 400V	CP6G	
C204 ABC	Capacitor, electrolytic, 40-20-20 uf -10/+100%, 250V	CE35	
C205	Capacitor, plastic, 0.1 uf $\pm 20\%$ , 200V	CF46	
C206	Capacitor, electrolytic, 100 uf -10/+100%, 3V	CE60	
C207	Capacitor, ceramic, 0.005 uf $\pm 20\%$ , 500V	CT17	
C208	Capacitor, plastic, 0.1 uf $\pm 20\%$ , 200V	CF46	
C209	Capacitor, plastic, 0.47 uf $\pm 20\%$ , 200V	CF48	
C210	Capacitor, plastic 0.1 uf $\pm 20\%$ , 200V	CF46	
C211	Capacitor, electrolytic, 5 uf -10/+100%, 50V	CE75	
C212	Capacitor, electrolytic, 500 uf -10/+100%, 3V	CE61	
C213 AB	Capacitor, electrolytic, 20-20 uf -10/+50%, 450V	CE5	
C214	Capacitor, electrolytic, 2000 uf -10/+100%, 25V	CE25	
C215	Capacitor, electrolytic, 30 uf -10/+100%, 15V	CE74	
C216	Capacitor, electrolytic, 15 uf -10/+150%, 6V	CE36	
CR201	Diode, silicon, type IN547, 0.75 Amp, 600 PIV	RE18	
CR202	Diode, silicon, type 2E4, 300 ma, 400 PIV	2E4	
CR213	Diode, silicon, type IN547, 0.75 Amp, 600 PIV	RE18	
CR204, CR205	Diode, silicon, type 2E4, 300 ma, 400 PIV	2E4	
G1	Chopper, electromechanical, SPDT	X2279	
Q201	Transistor, germanium PNP, special purpose 2N301W	*SC14	
Q202	Transistor, germanium PNP, 2N1372	2N1372	
R201 thru R203	Resistor, composition, 820K $\pm 10\%$ , 1/2W	EB8241	
R204	Resistor, composition, 2.2 Meg $\pm 10\%$ , 1/2W	EB2251	
R205	Resistor, composition, 22K $\pm 10\%$ , 1/2W	EB2231	
R206	Resistor, composition, 150K $\pm 10\%$ , 1/2W	EB1541	
R207	Resistor, composition, 4.7 K $\pm 10\%$ , 1/2W	EB4721	
R208	Resistor, composition, 10 Meg $\pm 10\%$ , 1/2W	EB1061	
R209	Resistor, composition, 10K $\pm 10\%$ , 1/2W	EB1031	

REFERENCE DESIGNATION	DESCRIPTION	FLUKE STOCK NO.	USE CODE
R210	Resistor, composition, 220K $\pm$ 10%, 1/2W	EB2241	
R211, R212	Resistor, composition, 1 Meg $\pm$ 10%, 1/2W	EB1051	
R213	Resistor, composition, 180K $\pm$ 10%, 1/2W	EB1841	
R214	Resistor, composition, 1K $\pm$ 10%, 1/2W	EB1021	
R215	Resistor, composition, 3.3 Meg $\pm$ 10%, 1/2W	EB3351	
R216	Resistor, composition, 1.5 Meg $\pm$ 10%, 1/2W	EB1551	
R217	Resistor, composition, 4.7K $\pm$ 10%, 1/2W	EB4721	
R218	Resistor, composition, 22K $\pm$ 10%, 1/2W	EB2231	
R219	Resistor, composition, 220 $\Omega$ $\pm$ 10%, 1/2W	EB2211	
R220	Resistor, carbon film, 10 $\Omega$ $\pm$ 1%, 1/2W	DR825	
R221	Resistor, carbon film, 75 $\Omega$ $\pm$ 1%, 1/2W	DR23	
R222	Resistor, variable wirewound, 500 $\Omega$ $\pm$ 10%, 2W	P500A	
R223, R224	Resistor, composition, 1.8K $\pm$ 10%, 1/2W	EB1821	
R225, R226	Resistor, composition, 47K $\pm$ 10%, 2W	HB4731	
R227	Resistor, composition, 2.2K $\pm$ 10%, 2W	HB2221	
R228	Resistor, composition 560K $\pm$ 10%, 1/2W	EB5641	
R229	Resistor, composition, 560 $\Omega$ , $\pm$ 10%, 1/2W	EB5611	
R230	Resistor, composition, 2.2K $\pm$ 10%, 2W	HB2221	
P231	Resistor, composition, 180K $\pm$ 10, 1/2W	EB1841	
R232	Resistor, variable wirewound, 10K $\pm$ 20%, 2W	P10KA	
R233	Resistor, composition, 100K $\pm$ 10%, 1/2W	EB1041	
R234	Resistor, carbon film, 2.7K $\pm$ 1%, 1/2W	DR415	
R235	Resistor, carbon film, 31.6K $\pm$ 1%, 1W	DR826	
R236	Resistor, composition, 22K $\pm$ 10%, 1/2W (may be omitted)	EB2231	
V201	Lamp, neon glow, type NE2E, 1/10W	X40B	
V202	Vacuum tube, duo triode, 5751	5751	
V203	Vacuum tube, triode-pentode, 6AW8A	6AW8A	
V204	Vacuum tube, voltage reference, OA2	OA2	
	Vacuum tube shield	X69	
	Vacuum tube clamp, 2 inches high	X445A	

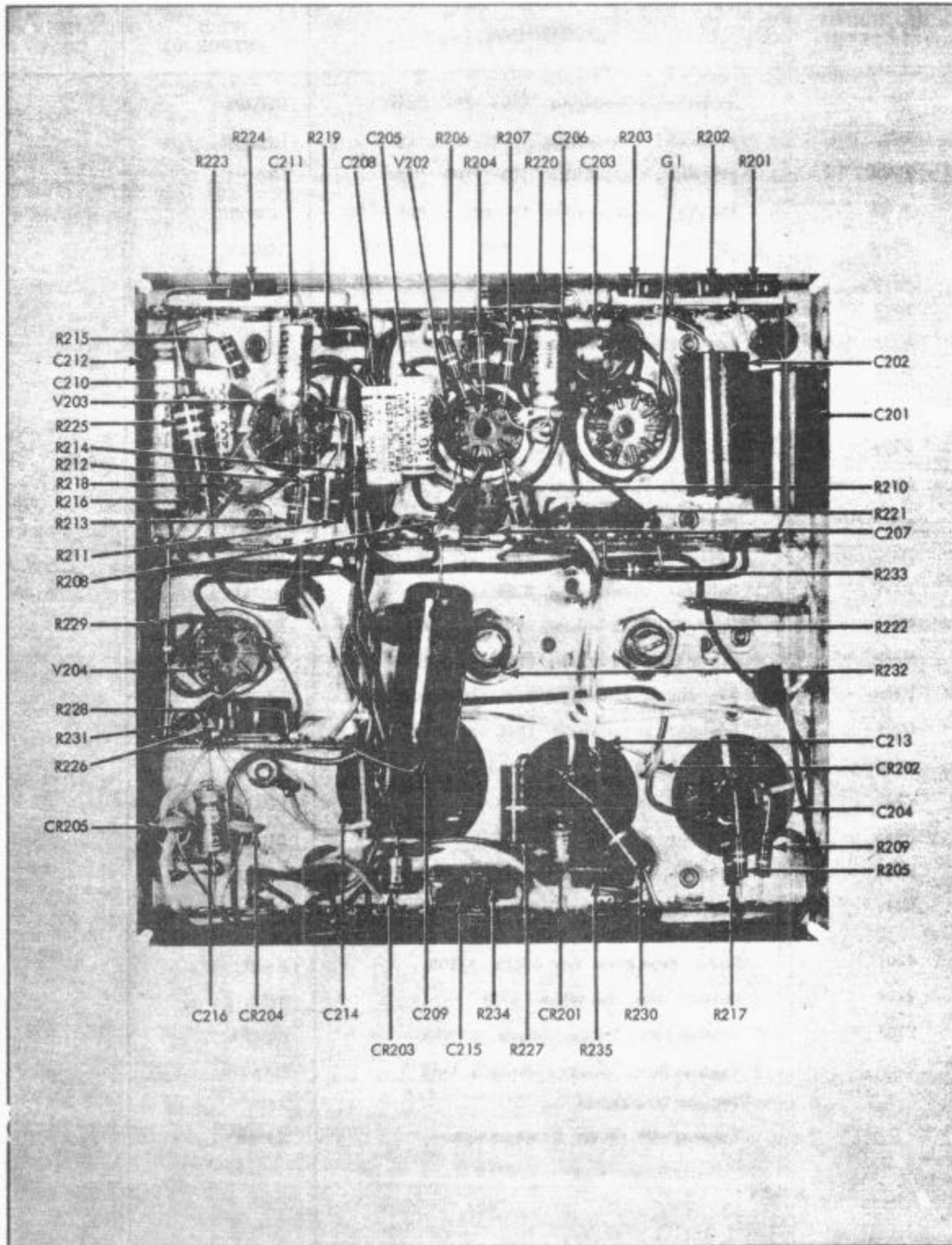

Figure 5-4. NULL DETECTOR CHASSIS ASSEMBLY

REFERENCE DESIGNATION	DESCRIPTION	FLUKE STOCK NO.	USE CODE
	Range Resistor Board Assembly	*803D-404 *803DR-430 *803D/AG-404	
C301	Capacitor, plastic, 1 uf $\pm 20\%$ , 600V	CP33	
C302	Capacitor, plastic, 2 uf $\pm 20\%$ , 200V	CF51	
CR301	Zener diode (803D/AG and 803DR/AG. If replacement is required, it will be necessary to replace both CR301 and R319 with Zener resistor pair 825A/G-426. In some cases, it may also be necessary to replace R3. This will be determined at the factory.)		
R301 thru R304	Resistor, carbon film, 10 Meg $\pm 1\%$ , 1W	DR80	
R305	Resistor, carbon film, 9 Meg $\pm 1\%$ , 1W	DR78	
R306	Resistor, carbon film, 900K $\pm 1\%$ , 1/2W	DR622	
R307	Resistor, carbon film, 90K $\pm 1\%$ , 1/2W	DR513	
R308	Resistor, carbon film, 9K $\pm 1\%$ , 1/2W	DR412	
R309	Resistor, carbon film, 900 $\Omega$ $\pm 1\%$ , 1/2W	DR824	
R310	Resistor, carbon film, 100 $\Omega$ $\pm 1\%$ , 1/2W	DR35	
R311 thru R315	Resistor, composition, 22 Meg $\pm 10\%$ , 1/2W	EB2261	
R316, R317	Resistor wirewound, 125K $\pm 0.1\%$ , 1W	PR610	
R318	Resistor, variable wirewound, 1K $\pm 20\%$ , 1-1/4W (803D and 803DR)	P1KE	
	Resistor, variable wirewound, 3K $\pm 20\%$ , 1-1/4W (803D/AG and 803DR/AG)	P3K	
R319	Resistor, wirewound, 511.7 $\Omega$ $\pm 0.1\%$ , 1/2W (803D and 803DR)	PR643	
	Resistor, wirewound (803D/AG and 803DR/AG. Optimum value is selected at factory to match Zener diode. When ordering, include date and serial number listed on Range Resistor Printed Circuit Board decal.)		
R320, R321	Resistor, wirewound, 112.375K $\pm 0.05\%$ , 1W	PR615	
R322	Resistor, composition, 27K $\pm 10\%$ , 1W	GB2731	
R323	Resistor, variable wirewound, 500 $\Omega$ $\pm 10\%$ , 1-1/4W	P500B	
R324	Resistor, wirewound, 28.571K $\pm 0.05\%$ , 1/2W	PR515	
R325	Resistor, wirewound, 22.5K $\pm 0.1\%$ , 1/2W	PR513	
R326	Resistor, variable wirewound, 500 $\Omega$ $\pm 10\%$ , 1-1/4W	P500B	
R327	Resistor, wirewound, 2531.7 $\Omega$ $\pm 0.05\%$ , 1/2W	PR49	
R328	Resistor, wirewound, 24.75K $\pm 0.1\%$ , 1/2W	PR514	
R329	Resistor, variable wirewound, 500 $\Omega$ $\pm 10\%$ , 1-1/4W	P500B	
R330	Resistor, wirewound, 250.31 $\Omega$ $\pm 0.05\%$ , 1/2W	PR311	
R331	Resistor, composition, 270 $\Omega$ $\pm 10\%$ , 1/2W	EB2711	

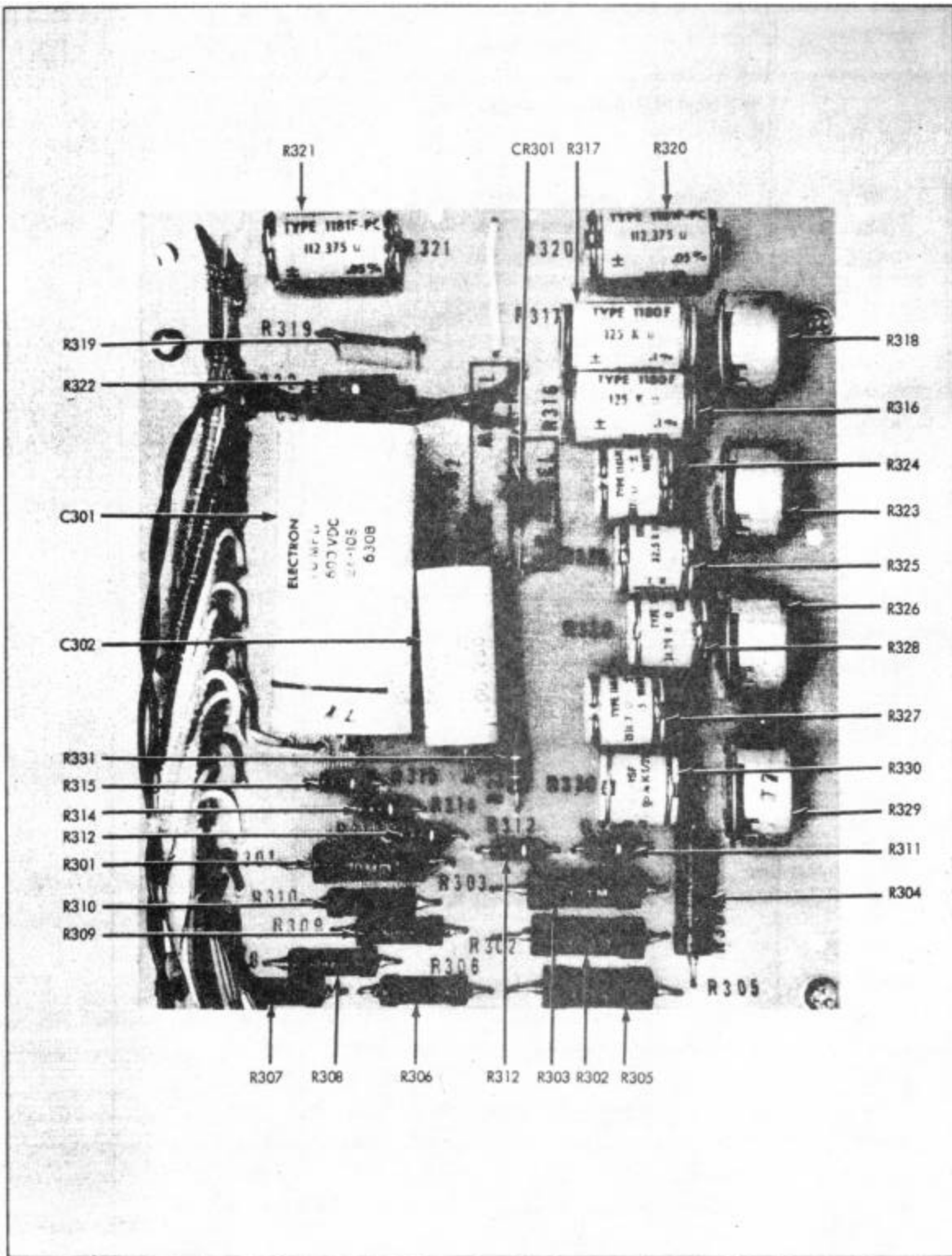

Figure 5-5. RANGE RESISTOR BOARD ASSEMBLY

REFERENCE DESIGNATION	DESCRIPTION	FLUKE STOCK NO.	USE CODE
R401 thru R406**	Kelvin-Varley Resistor Board Assembly Resistor, wirewound, 40K $\pm$ 0.02%, 1/2W	*801B-403 *PR512	
R407 thru R417**	Resistor, wirewound, 8K $\pm$ 0.02%, 1/2W	*PR48	
R418 thru R428**	Resistor, wirewound, 1.6K $\pm$ 0.01%, 1/8W	*34-2121	
R429 thru R439**	Resistor, wirewound, 32 $\Omega$ $\pm$ 0.1%, 1/2W	*PR39	
R440 thru R449	Resistor, wirewound, 64 $\Omega$ $\pm$ 0.1%, 1/2W	*PR24	

\*\*These resistors are factory matched for each instrument. When ordering, specify instrument serial number.

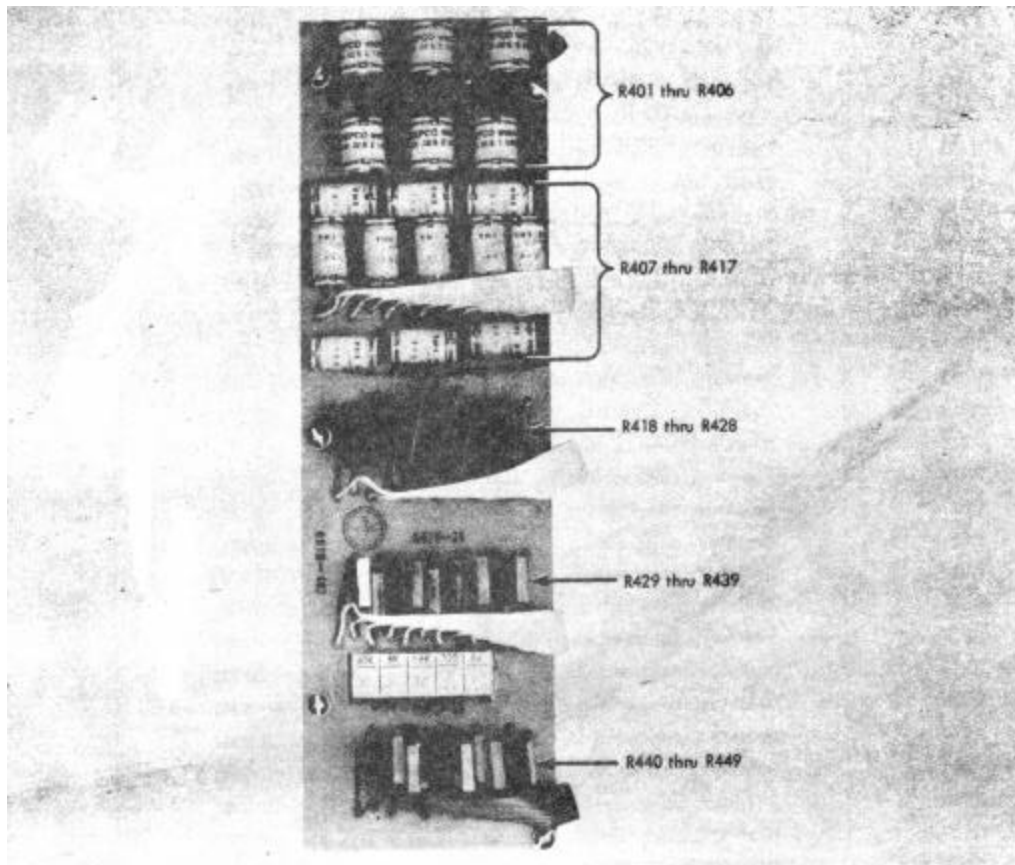

Figure 5-6. KELVIN-VARLEY RESISTOR BOARD ASSEMBLY

REFERENCE DESIGNATION	DESCRIPTION	FLUKE STOCK NO.	USE CODE
CR501, CR502	Converter/AC Range Switch Assembly Diode, silicon, 60 ma Converter Assembly	*803D-438 RE22 *803D-439	
C505AB	Capacitor, electrolytic, 10-10 uf -10/+50%, 500V	CE20	
C506	Capacitor, ceramic, 0.005 uf ±20%, 500V	CT17	
C507	Capacitor, ceramic, 300 uf ±10%, 500V	CT28	
C508	Capacitor, plastic, 0.47 uf ±20%, 200V	CF48	
C509	Capacitor, plastic, 0.0068 uf ±20%, 400V	CF53	
C510	Capacitor, ceramic, 500 uuf -0%, 500V	CT21	
C511	Capacitor, plastic, 0.47 uf ±20%, 200V	CF48	
C512	Capacitor, paper, 0.1 uf ±20%, 400V	CP4	
C513	Capacitor, electrolytic, 20 uf -10/+100%, 50V	CE41	
C514	Capacitor, ceramic, 2.2 uf -0%, 3V	CT45	
C515	Capacitor, plastic, 2 uf ±20%, 200V	CF51	
C516	Capacitor, paper, 1 uf ±20%, 600V	CP33	
C517	Capacitor, plastic, 5 uf ±20%, 200V	CP36	
C518	Capacitor, plastic, 2 uf ±20%, 200V	CF51	
C522	Capacitor, electrolytic, 500 uf -10/+100%, 3V	CE61	
CR503	Diode, silicon, 300 ma, 400 PIV	2E4	
R506, R507	Resistor, metal film, 68K ±5%, 2W	MR45	
R508	Resistor, metal film, 56K ±5%, 2W	MR44	
R509	Resistor, metal film, 100K ±5%, 5W	MR43	
R510, R511	Resistor, composition, 3.3K ±10%, 1/2W	EB3321	
R512	Resistor, composition, 220Ω ±10%, 1/2W	EB2211	
R513	Resistor, composition, 270Ω ±10, 1/2W	EB2711	
R514	Resistor, composition, 1.8 Meg ±10%, 1/2W	EB1851	
R515	Resistor, composition, 2.2 Meg ±10%, 1/2W	EB2251	
R516	Resistor, composition, 15 Meg ±10%, 1/2W	EB1561	
R517	Resistor, composition, 18 Meg ±10%, 1/2W	EB1861	
R518	Resistor, composition, 1.8 Meg ±10%, 1/2W	EB1851	
R519	Resistor, composition, 47Ω ±10%, 1/2W	EB4701	
R520	Resistor, metal film, 120K ±5%, 2W	MR46	
R521	Resistor, composition, 180Ω ±10%, 1/2W	EB1811	
R522	Resistor, composition, 10K ±10%, 1/2W	EB1031	
R523	Resistor, composition 390Ω ±10%, 1/2W	EB3911	
R524	Resistor, composition, 330K ±10%, 1/2W	EB3341	
R525	Resistor, composition, 470K ±10%, 1/2W	EB4741	
R526	Resistor, composition, 220K ±10%, 1/2W	EB2241	
R527	Resistor, composition 47Ω ±10%, 1/2W	EB4701	
R528	Resistor, metal film, 150K ±5%, 2W	MR47	
R529	Resistor, composition, 100K ±10%, 1W	GB1041	



REFERENCE DESIGNATION	DESCRIPTION	FLUKE STOCK NO.	USE CODE
R530	Resistor, metal film, 47K $\pm$ 5%, 5W	MR42	
R531	Resistor, composition, 220 $\pm$ 10%, 1/2W	EB2211	
R532	Resistor, composition, 470K $\pm$ 10%, 1/2W	EB4741	
R536	Resistor, variable wirewound, 500 $\Omega$ $\pm$ 10%, 1/4W	P500T	
R537	Resistor, carbon film, 100K $\pm$ 1%, 1/2W	DR61	
R538	Resistor, wirewound, 21.28K $\pm$ 0.1%, 1/2W	PR704	
R539	Resistor, wirewound, 490 $\Omega$ $\pm$ 0.1%, 1/2W	PRA18	
R545	Resistor, variable wirewound, 25 $\Omega$ $\pm$ 10%, 1-1/4W	P25A	
V501	Vacuum, pentode, 6EJ7	6EJ7	
V502	Vacuum tube, triode-pentode, 6AW8A	6AW8A	
	AC Range Switch Assembly	*803D-440	
	AC Range Switch Gain Adjust Assembly	*803D-440-1	
R533	Resistor, variable wirewound 100 $\Omega$ $\pm$ 20%, 1-1/4W	P100M	
R541	Resistor, variable wirewound 50 $\Omega$ $\pm$ 20%, 1-1/4W	P50E	
R544	Resistor, variable wirewound 10 $\Omega$ $\pm$ 20%, 1-1/4W	P10	
	AC Range Switch Attenuator Assembly	*803D-440-2	
C501	Capacitor, variable glass 0.8 to 8.5 uuf, 1250V	CT68	
C502	Capacitor, ceramic, 39 uuf $\pm$ 2%, 600V	CT15	
C503	Capacitor, plastic, 0.18 uf $\pm$ 10%, 600V	CF55	
C521	Capacitor, ceramic, 300 uuf $\pm$ 5%, 600V	CT13	
C523	Capacitor, variable glass 0.8 to 8.5 uuf, 1250V	CT68	
C524	Capacitor, ceramic, 5 uuf $\pm$ 10%, 500V	CT70	
R503	Resistor, variable wirewound 5K $\pm$ 10%, 1/4W	P5KTA	
R535	Resistor, variable wirewound 500 $\pm$ 10%, 1/4W	P500T	
	Matched Resistor Set	*DRMF80	
R501	Resistor, metal film, 1 Meg $\pm$ 1/2%, 1W		
R502	Resistor, metal film, 122.61 $\pm$ 1%, 1/2		
R534	Resistor, metal film, 10K $\pm$ 1%, 1/2W		
	AC Range Switch Gain Network Assembly	*803D-440-3	
C504, C519	Capacitor, variable glass 0.8 to 8.5 uuf, 1250V	CT68	
C520	Capacitor, ceramic, 82 uuf $\pm$ 2%, 600V	CT36	
R505	Resistor, composition, 47 $\Omega$ $\pm$ 10%, 1/2W	EB4701	
R542	Resistor, variable wirewound 2K $\pm$ 10%, 1/4W	P2KTA	

REFERENCE DESIGNATION	DESCRIPTION	FLUKE STOCK NO.	USE CODE
R504 R540 R543	Matched Resistor Set Resistor, metal film, 1 Meg $\pm 1/2\%$ , 1/2W Resistor, metal film, 48.75K $\pm 1\%$ , 1/2W Resistor, metal film, 500K $\pm 1/2\%$ , 1/2W	*DRMF81	
S2	AC Range Switch Assembly Switch, range, AC section	*803D-440-4 *803D-811	

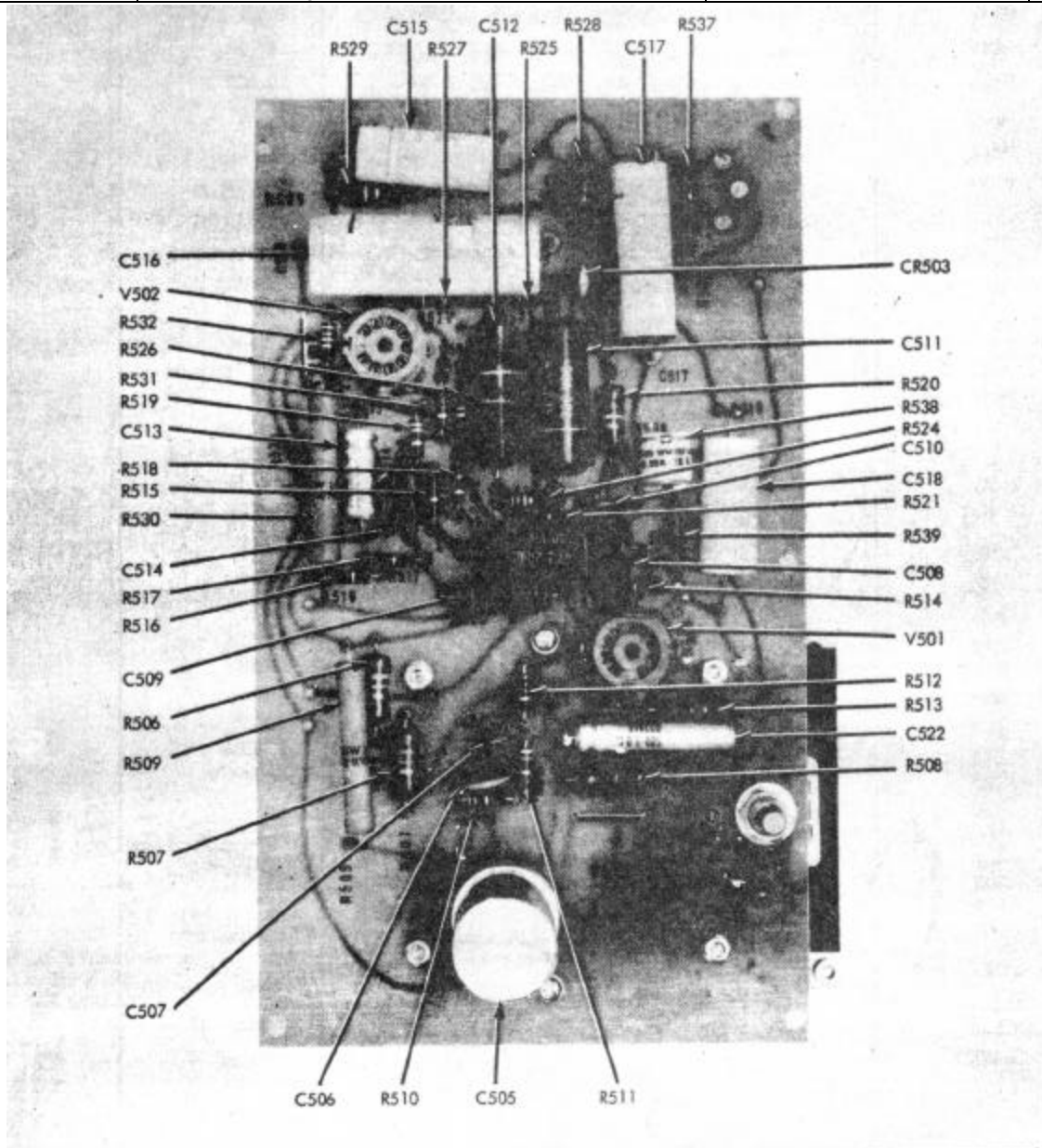

Figure 5-7. CONVERTER/AC RANGE SWITCH ASSEMBLY (Sheet 1 of 2)

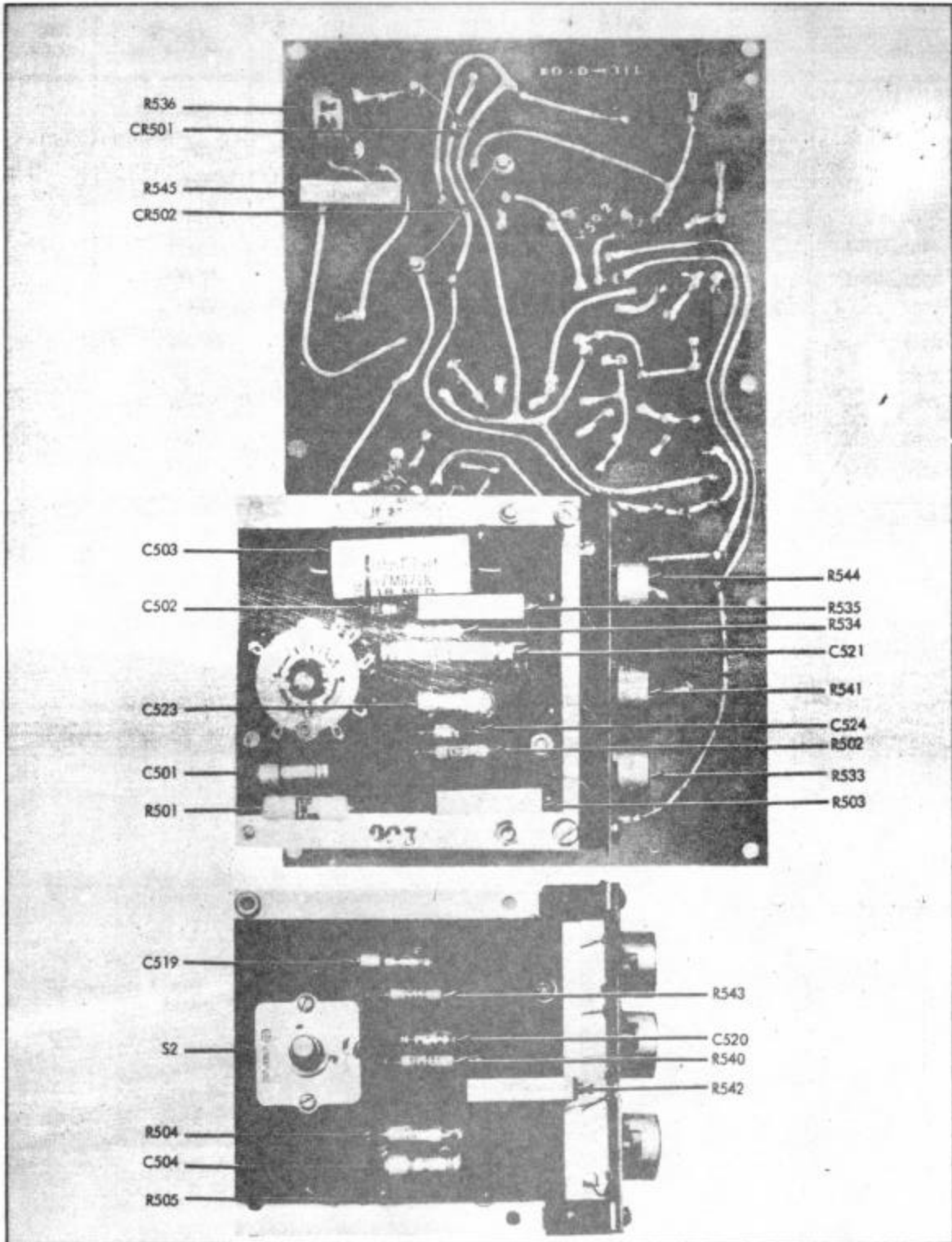

Figure 5-7. CONVERTER/AC RANGE SWITCH ASSEMBLY (Sheet 2 of 2)

REFERENCE DESIGNATION	DESCRIPTION	FLUKE STOCK NO.	USE CODE
	Chopper Drive Assembly	*803C-450	
C701	Capacitor, plastic, 0.18 uf ±10%, 200V	CF21	
C702, C703	Capacitor, electrolytic, 20 uf -10/+100%, 50V	CE41	
C704	Capacitor, plastic, 0.18 uf ±10%, 200V	CF21	
Q701, Q702	Transistor, germanium, PNP, 2N1379	2N1379	
Q703, Q704	Transistor, germanium, PNP, 2N1372	2N1372	
R701	Resistor, deposited carbon, 44.2K ±1%, 1/2W	DR833	
R702	Resistor, composition, 120Ω ±10%, 1/2W	EB1211	
R703	Resistor, deposited carbon, 44.2K ±1%, 1/2W	DR833	
R704, R705	Resistor, variable wirewound, 10K ±20%, 1-1/4W	P10KD	
R706, R707	Resistor, composition, 820Ω ±10%, 1/2W	EB8211	
R708, R709	Resistor, composition, 120Ω ±10%, 1W	GB1211	

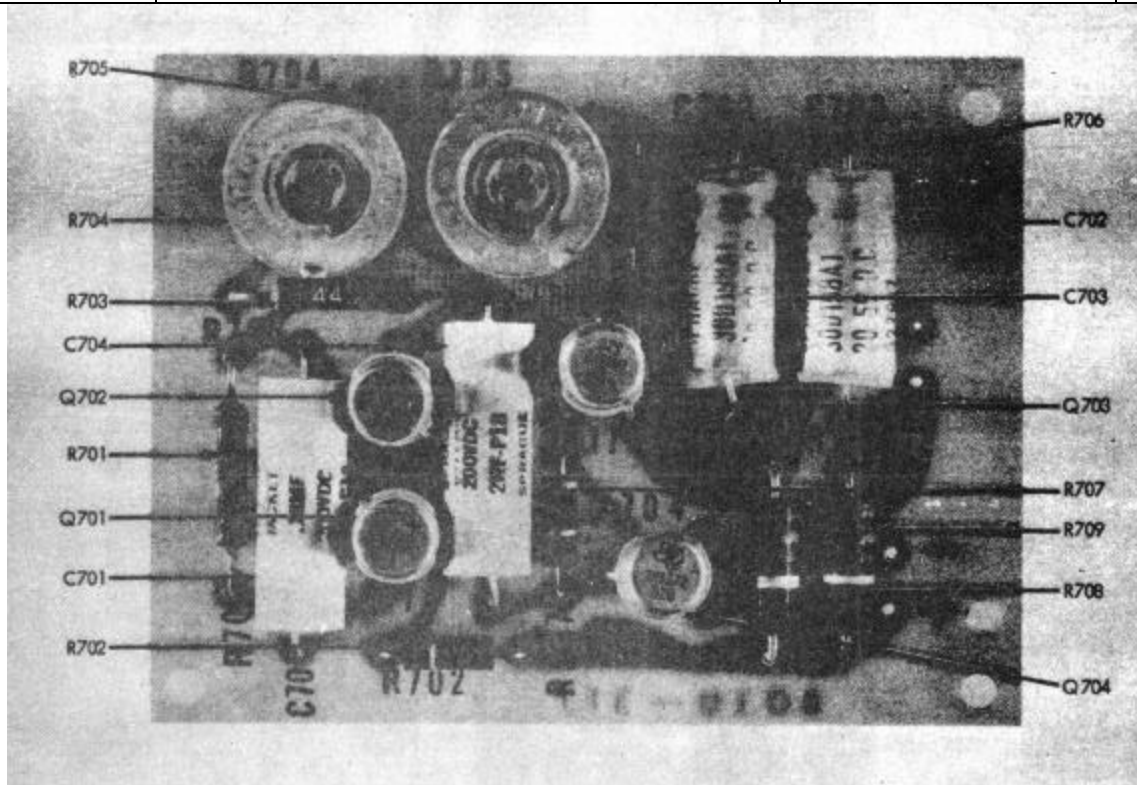

Figure 5-8. CHOPPER DRIVE ASSEMBLY

## USE CODE EFFECTIVITY

The following list of use codes is intended to allow the customer to determine the effectivity of all replaceable parts. All parts with no code are used on all instruments with serial numbers above 123. New codes will be added as necessary on forthcoming instruments.

USE CODE	EFFECTIVITY
No Code	Model 803D serial number 123 and on Model 803DR serial number 123 and on Model 803D/AG serial number 123 and on Model 803DR/AG serial number 123 and on
A	Model 803D serial number 123 thru 187 Model 803DR serial number 123 thru 172 Model 803D/AG serial number 123 thru 187 Model 803DR/AG serial number 123 thru 172
B	Model 803D serial number 188 and on Model 803DR serial number 173 and on Model 803D/AG serial number 188 and on Model 803DR/AG serial number 173 and on

**SECTION VI**  
**ACCESSORIES**

**6-1. PRECISION VOLTAGE DIVIDERS**

The Fluke 80A, 80B, and 80C Precision Voltage Dividers provide the  800 Series Differential Voltmeters with the ability to make high accuracy measurements up to 30,000 volts DC. All models contain a zero center panel meter which allows the polarity and approximate magnitude of the unknown high voltage to be easily observed. At maximum input, all units draw but 1 ma of current from the unknown. The extreme accuracy and excellent long term stability of these dividers are obtained by using properly aged precision wirewound resistors which have a very low temperature coefficient. To further ensure high accuracy and long term stability at very high voltages, the 80C dividers have all resistance components immersed in oil within a hermetically sealed container. As an additional feature, all 80B and 80C models are provided with a 1 volt tap which allows measurements of high voltages with a laboratory potentiometer. Specifications for the standard models are shown on next page. Other intermediate models are available upon special request.

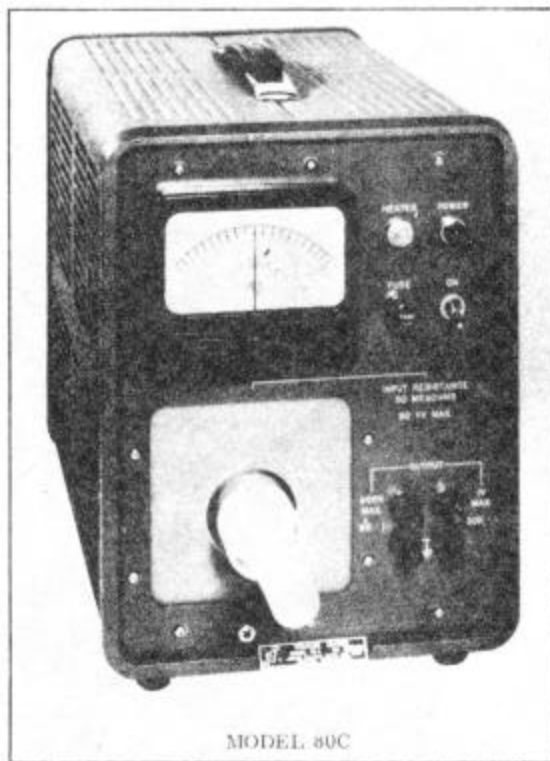
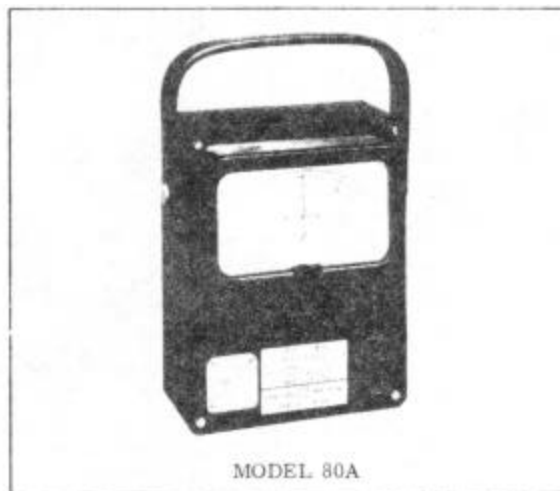

Model No.	Maximum Input Voltage	Total Resistance	Current Drawn At Max. Input	Division Ratio		Division Accuracy	Stability of Division Accuracy Per Year	Temp. Coef. of Division Ratio
				500 V Out	1 V Out			
80A-1 80A-2	1 KV 2 KV	1M 2 M	1 ma	2:1 4:1	———— ————	±0.015%	————	————
80B-5 80B-10	5 KV 10 KV	5 M 10 M	1 ma	10:1 20:1	5,000:1 10,000:1	±0.01%	±0.005%	±0.005%/°C from 0°C to 60°C
80C-15 80C-20 80C-25 80C-30	15 KV 20 KV 25 KV 30 KV	15 M 20 M 25 M 30 M	1 ma	30:1 40:1 50:1 60:1	15,000:1 20,000:1 25,000:1 30,000:1	±0.01%	±0.0005%	±0.0002%/°C from 0°C to 35°C

MODELS	SIZE	INPUT CONNECTOR	OUTPUT CONNECTOR
80A	6-3/4" high 5-1/4" wide 2-1/4" deep	UG-560U with mating connector supplied	Insulated binding posts on 3/4" centers
80B	10-9/32" high 8" wide 10" deep	AN3102-18-165 with mating connector supplied	Insulated binding posts on 3/4" centers for both outputs
80C	13" high 9-3/4" wide 16" deep	Special 5" ceramic standoff with mating 8" polystyrene connector supplied	Insulated binding post on 3/4" centers for both outlets



6-2. POTENTIOMETRIC RECORDER

The Fluke Model A-70 Self Balancing Potentiometric Recorder is a special purpose high sensitivity recorder developed for monitoring voltages measured by the  800 Series Differential Voltmeters. In addition to providing a permanent record of results, the recorder allows unattended monitoring of various voltages from 0 to 500 volts for long periods of time. A sample voltage which varies in direct proportion to the source under measurement is obtained from the voltmeter null detector by connecting the recorder to the output terminals at the rear of the voltmeter. A gain adjustment control adjacent to the voltmeter output terminals allows the sample voltage to be adjusted such that full-scale meter deflection equals full-scale recorder deflection. The large leakage resistance (500,000 megohms) between the recorder input posts and chassis is such that the inherently high accuracy of the Fluke Differential Voltmeter is generally not impaired in any way.

Electrical Span:	10 mv DC
Span Step Response Time:	Less than 0.5 seconds
Accuracy:	0.5% of span
Chart Speeds:	0.75, 1.5, 3.6, or 12 in. /min. or in./hr.
Dimensions:	Cabinet Model - Cabinet Model--9-1/4" high, 8-1/4" wide, 15" deep. Rack Model--Available on special request.

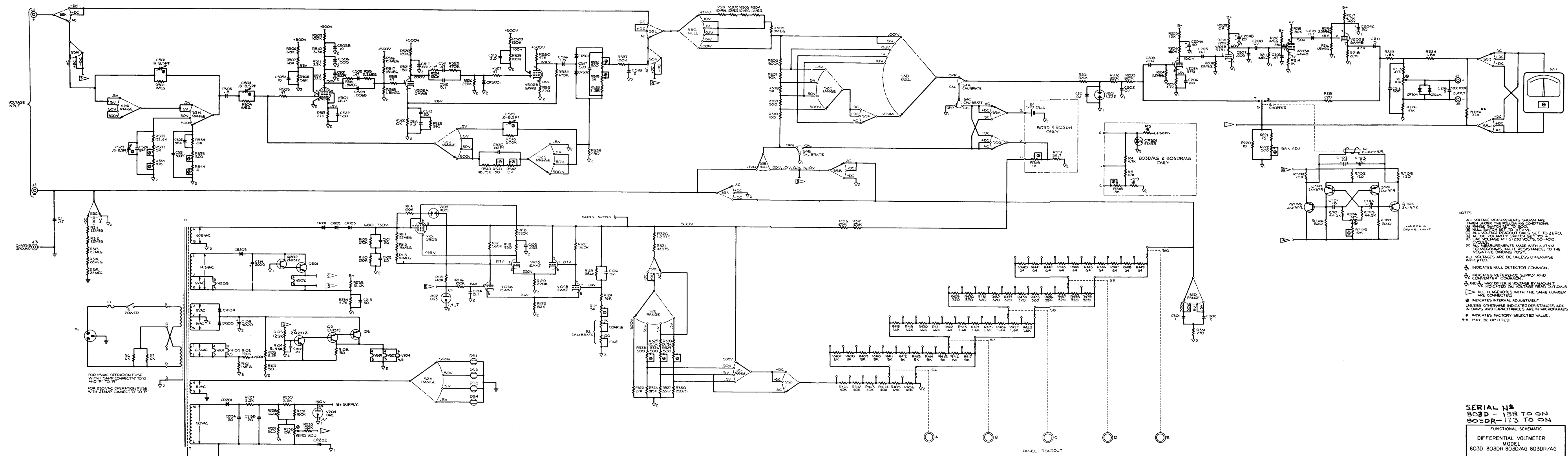

- NOTES
- (1) ALL VOLTAGE MEASUREMENTS SHOWN ARE TAKEN UNDER THE FOLLOWING CONDITIONS:
    - (A) RANGE SWITCH SET TO 500V
    - (B) NULL SWITCH SET TO VTVM
    - (C) ALL VOLTAGE INPUT DIALS SET TO ZERO
    - (D) RANGE SELECTOR SWITCH SET TO 500V
    - (E) LINE VOLTAGE AT 115/230 VOLTS TO 400 VOLT
  - (2) ALL MEASUREMENTS MADE WITH VTVM TO NEGATIVE INDICATOR RESISTANCE TO THE NEGATIVE BINDING POST.
- ALL VOLTAGES ARE DC UNLESS OTHERWISE INDICATED.
- ∅ INDICATES MALL DETECTOR COMMON.
  - ∅<sub>2</sub> INDICATES REFERENCE SUPPLY AND CONVERTER COMMON.
  - ∅<sub>3</sub> NO. 1 MAY DIFFER IN VOLTAGE BY AMOUNT ARE CONNECTED ON VOLTAGE READ DIALS
  - ∅ INDICATES INTERNAL ADJUSTMENT UNLESS OTHERWISE INDICATED RESISTANCES ARE IN OHMS AND CAPACITANCES ARE IN MICROFARADS.
  - INDICATES FACTORY SELECTED VALUE.
  - MAY BE OMITTED.

SERIAL N°  
 803D - 128 TO ON  
 803DR - 113 TO ON

FUNCTIONAL SCHEMATIC  
 DIFFERENTIAL VOLTMETER  
 MODEL  
 803D 803DR 803D/AG 803DR/AG

JOHN FLUKE MANUFACTURING COMPANY  
 MOUNTLAKE TERRACE WASHINGTON



HEADQUARTERS  
DEPARTMENT OF THE ARMY  
WASHINGTON, D.C., 30 March 1964

TM 9-4935-282-34, Field Maintenance Manual, Voltmeter, Electronic, John Fluke Model 803D, FSN 6625-072-4303, is published for use of all concerned.

By Order of the Secretary of the Army:

Official:

EARLE G. WHEELER,  
*General, United States Army,*  
*Chief of Staff.*

J. C. LAMBERT,  
*Major General, United States Army,*  
*The Adjutant General.*

Distribution:

To be distributed in accordance with DA Form 12-32, Section III (Unclassified) requirements for TM's-Test equipment (ORD) - Pershing and Sergeant missile system.

GPO 827-099-1

